

Luft-Wasser-Wärmepumpe

LA 9S-TUR

LA 12S-TUR

1

electrical layout

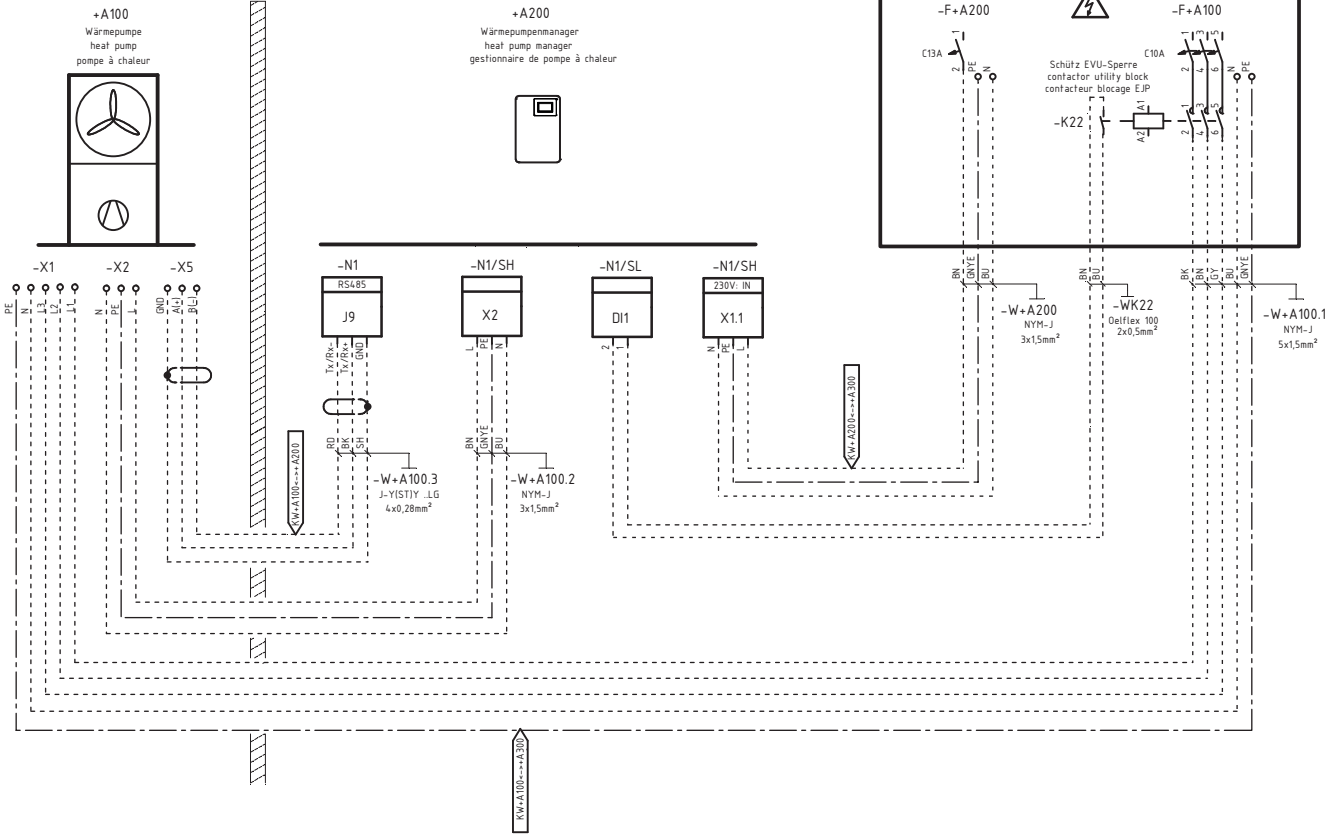



2

hydraulic

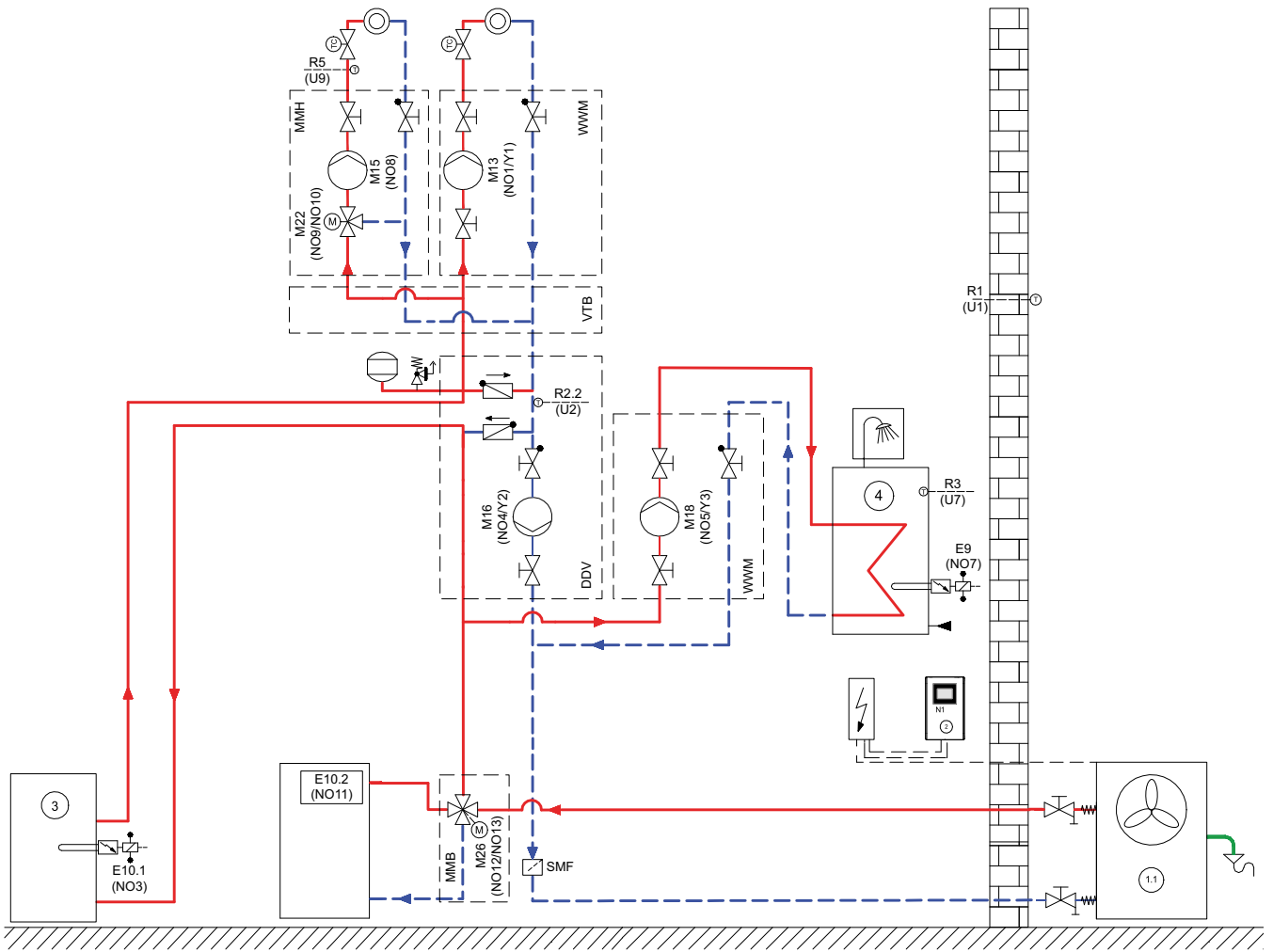

hydraulic 1

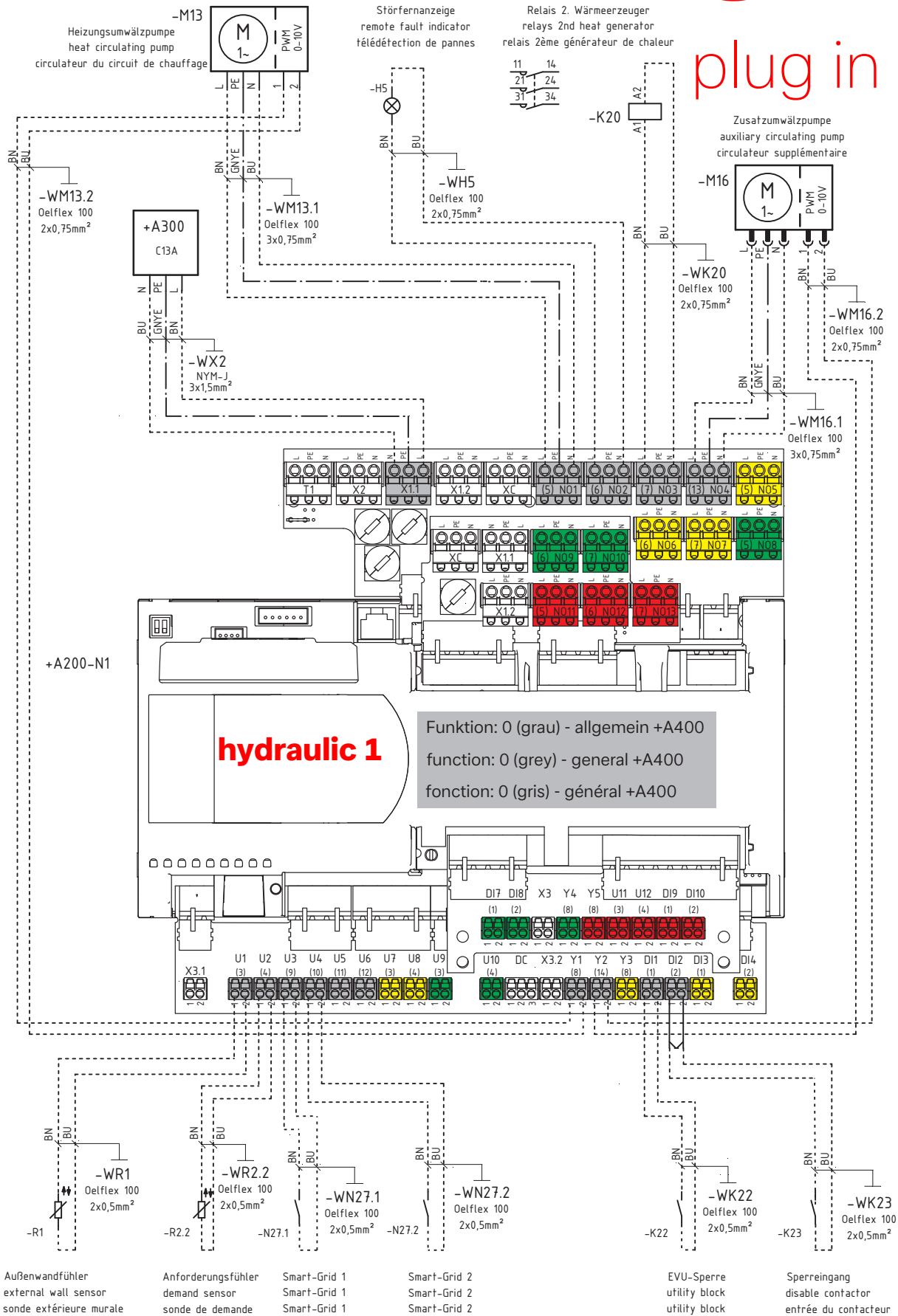

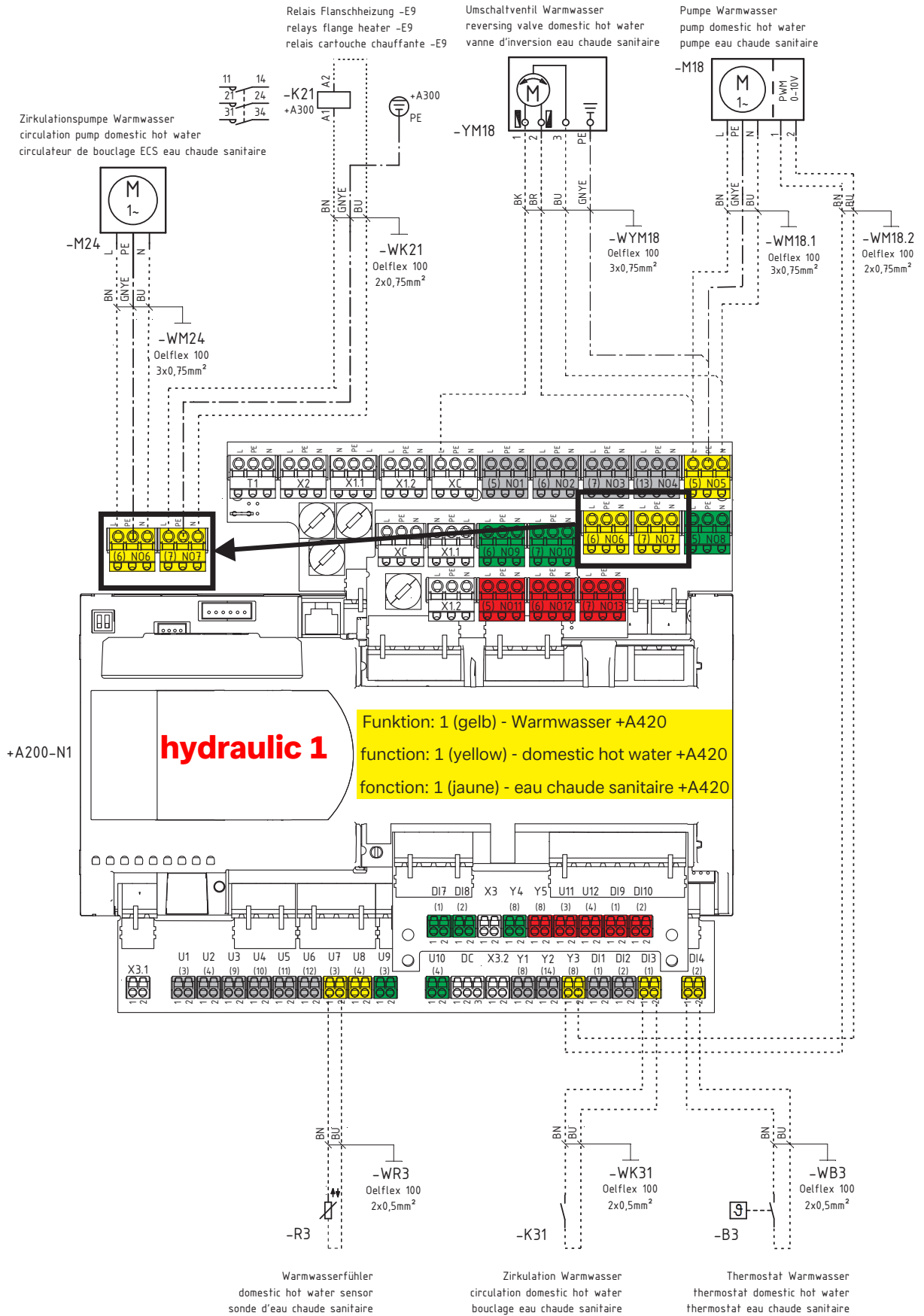

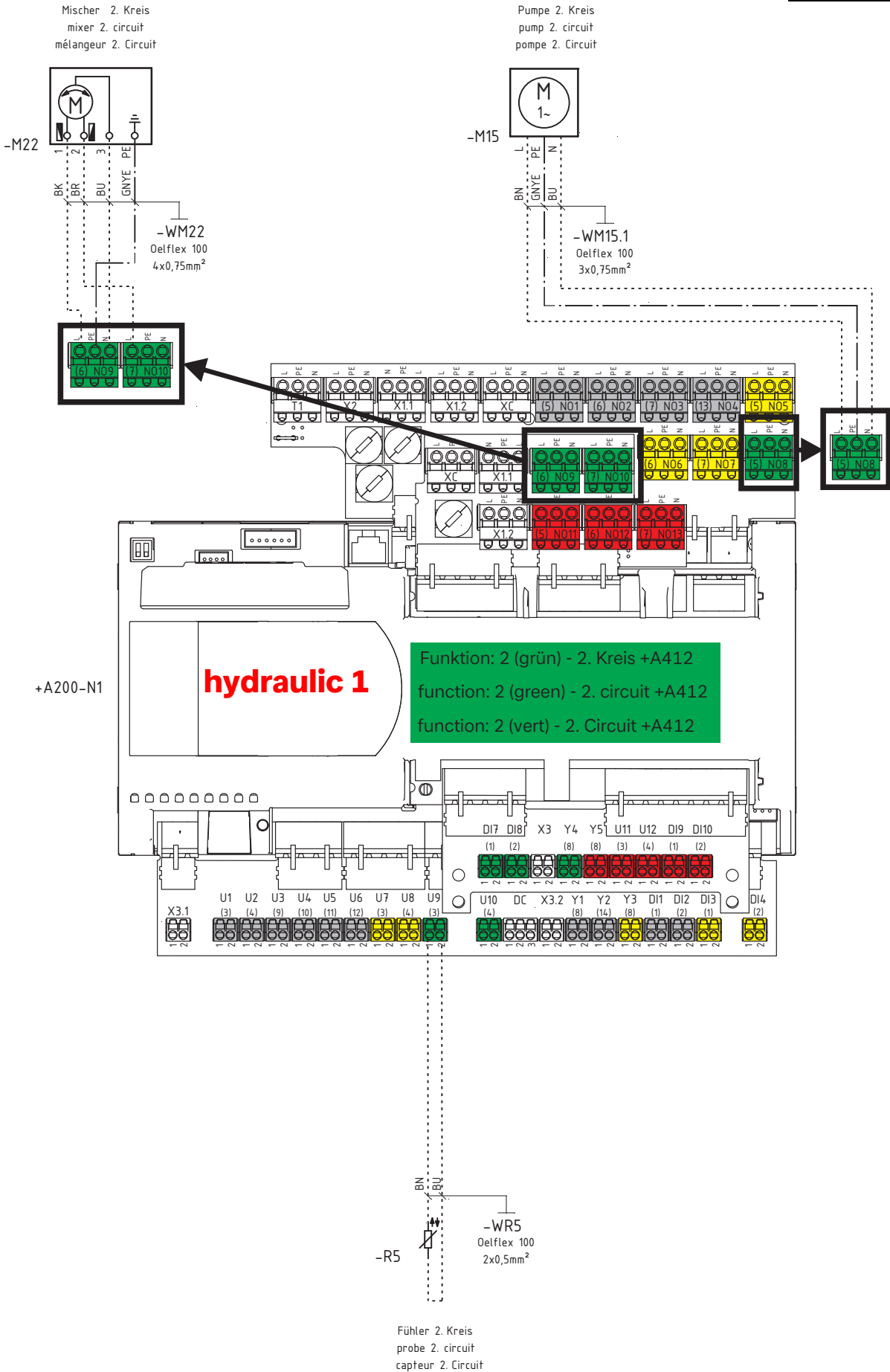



Wärmeerzeuger bivalent
heat generator bivalent
générateur de chaleur bivalente

Mischer bivalent
mixer bivalent
mélangeur bivalent

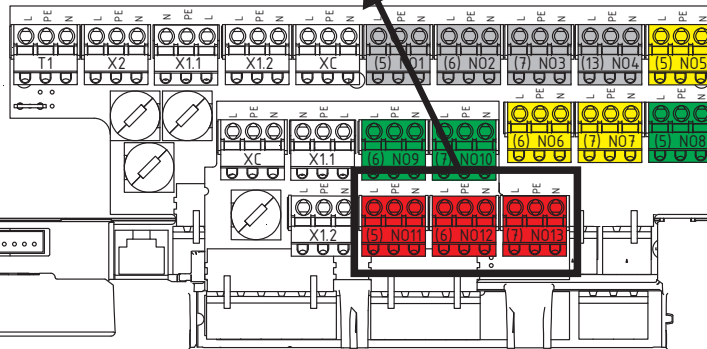
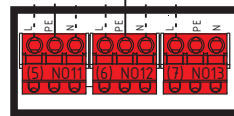
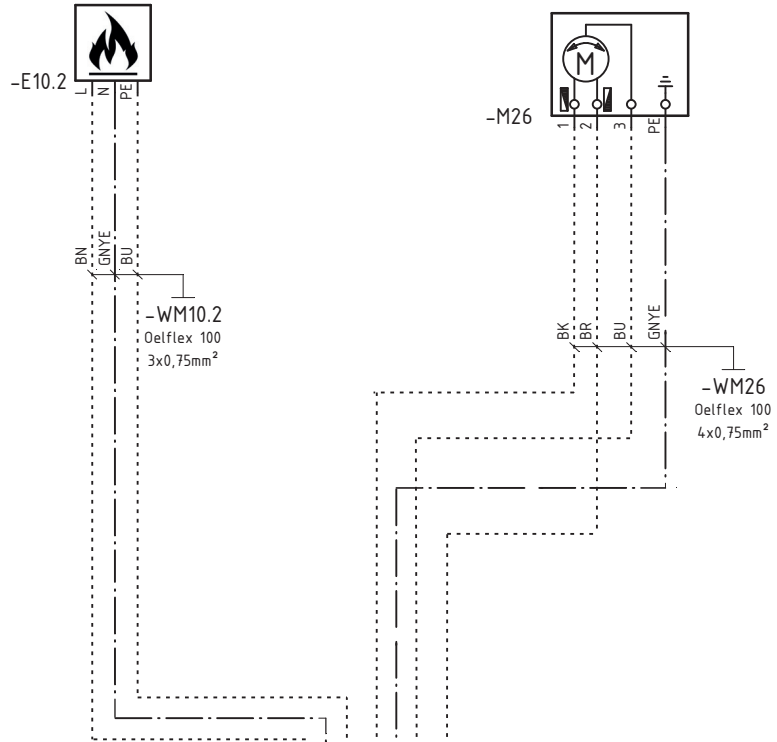

+A200-N1

hydraulic 1

Funktion: 3 (rot) - bivalent +A441
 function: 3 (red) - bivalent +A441
 fonction: 3 (rouge) - bivalent +A441

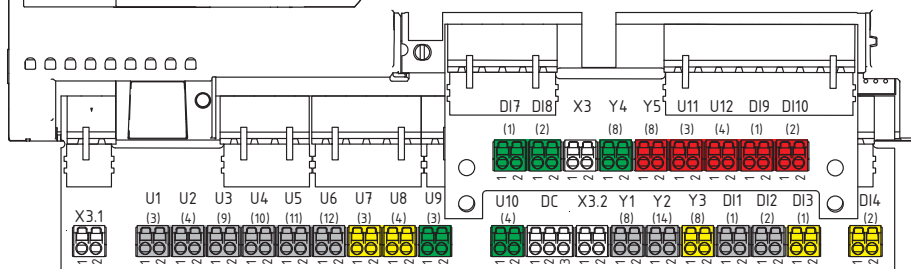

4



hydraulic

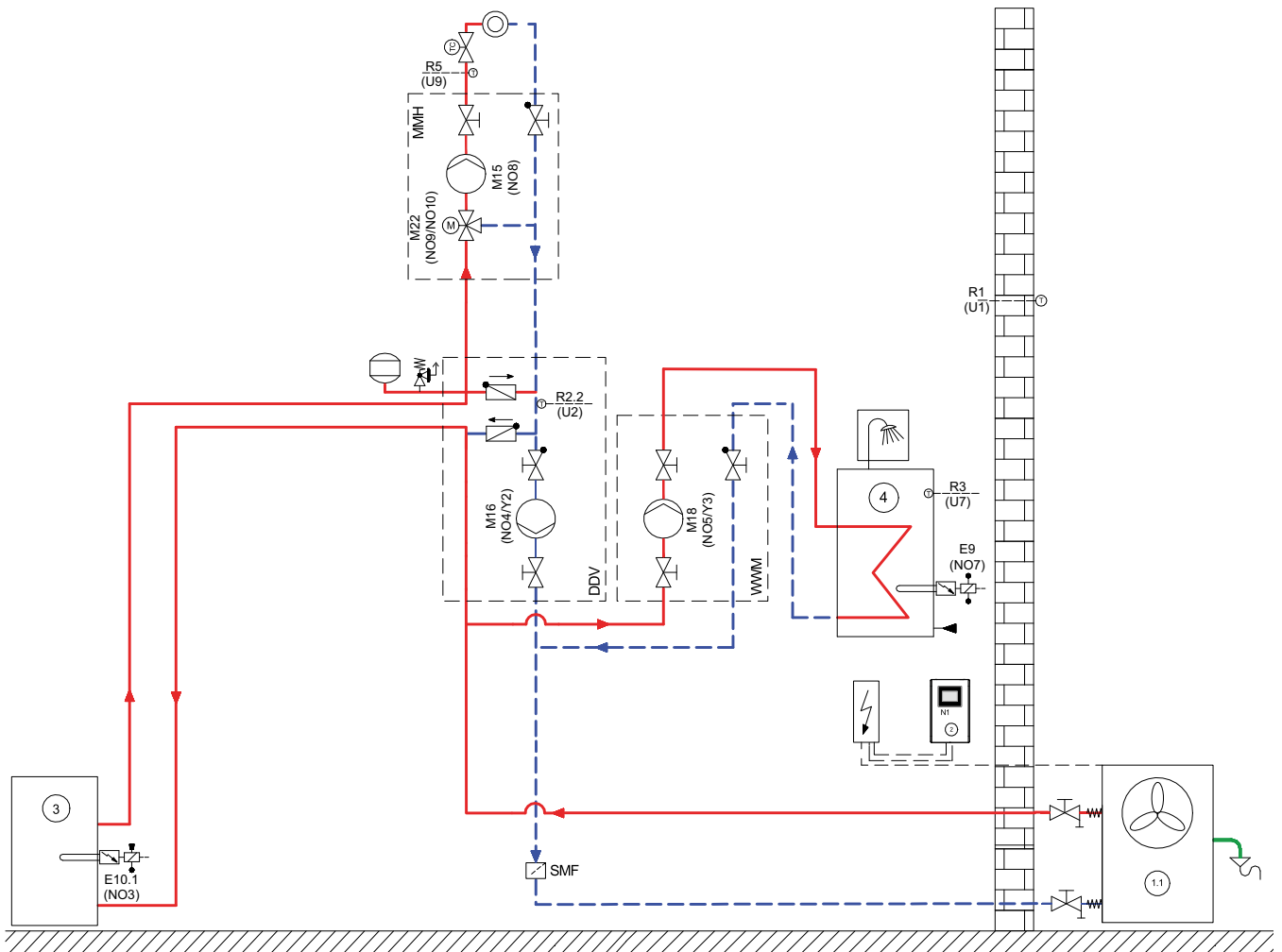

hydraulic 2

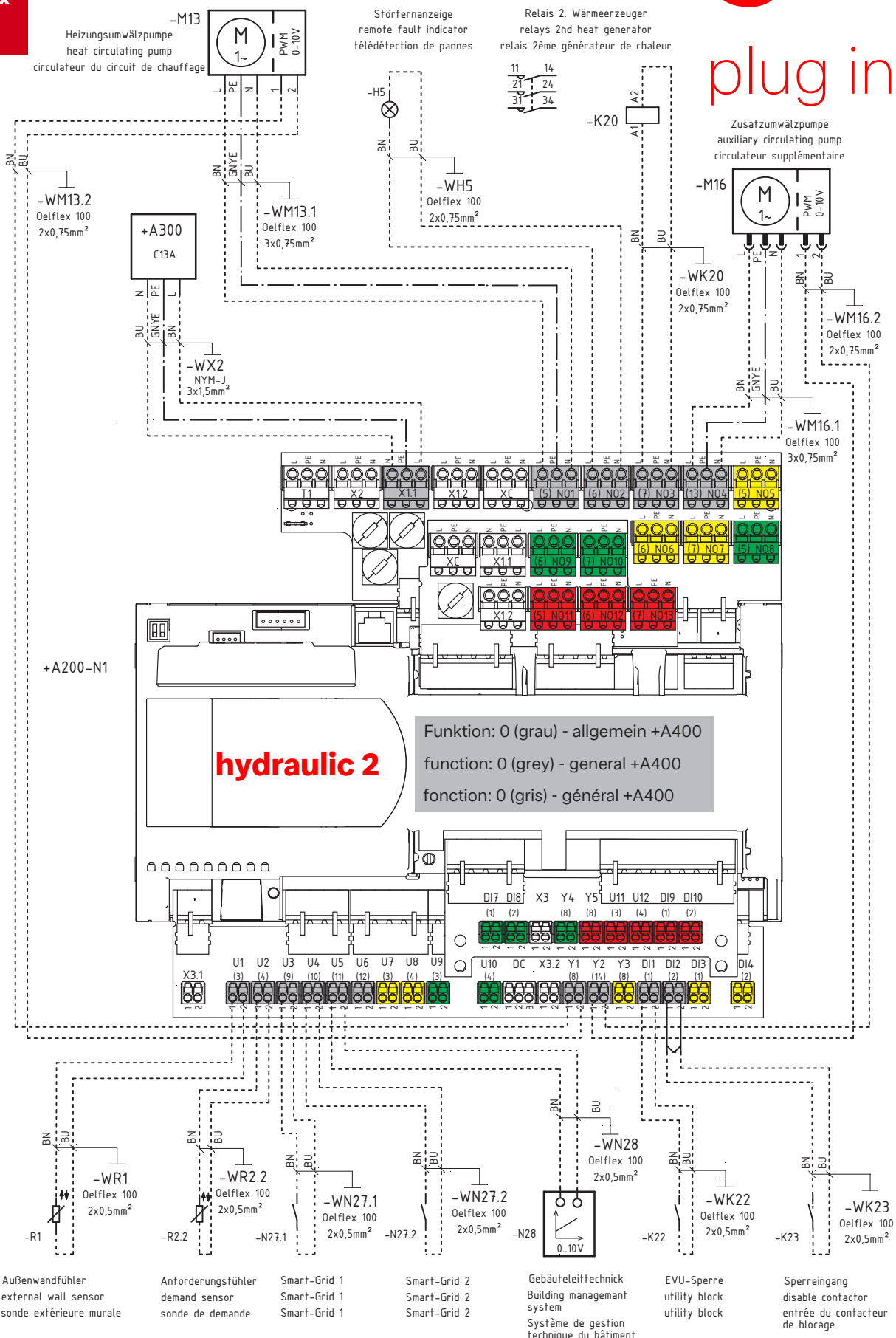

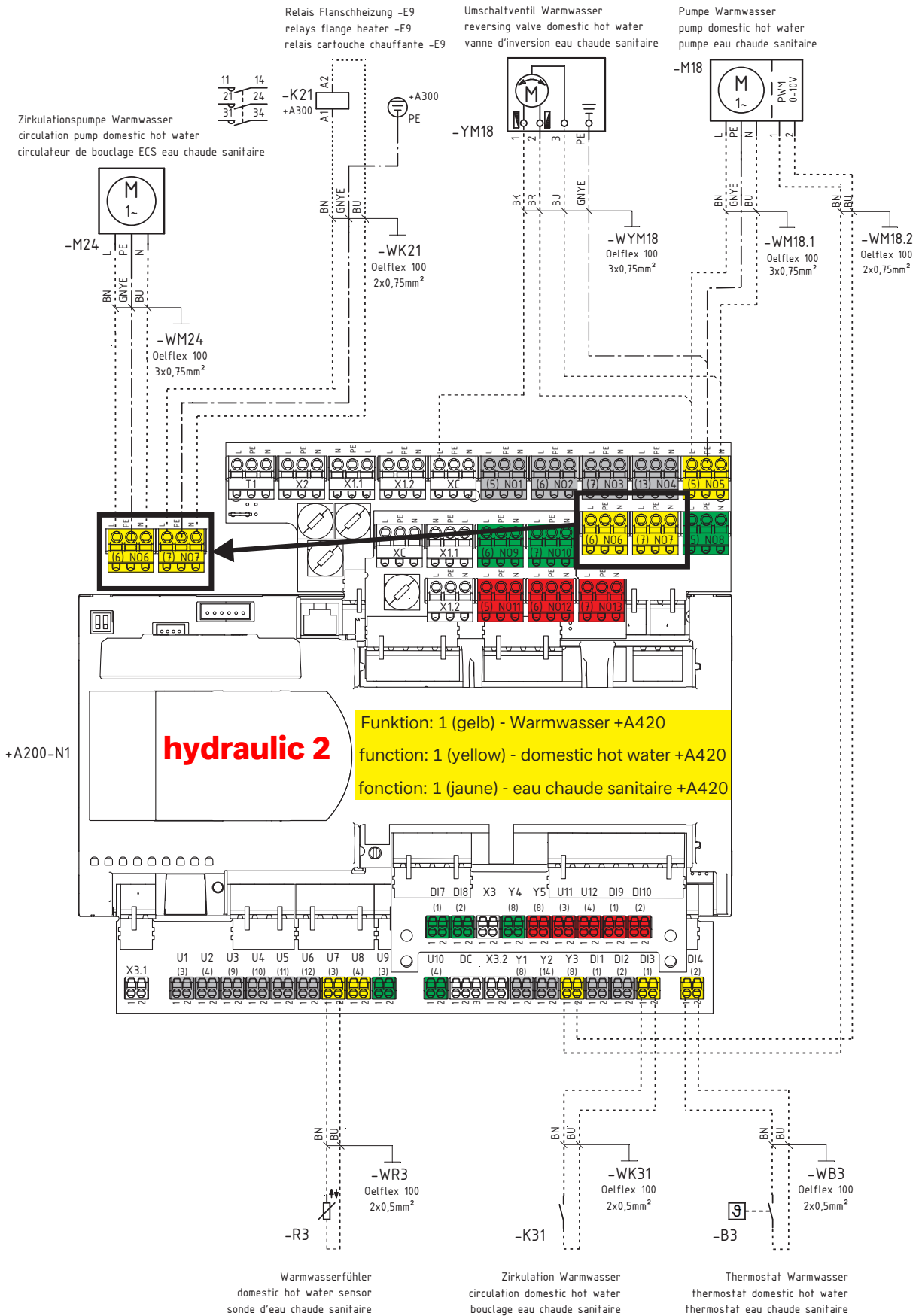



Mischer 2. Kreis
mixer 2. circuit
mélangeur 2. Circuit

Pumpe 2. Kreis
pump 2. circuit
pompe 2. Circuit

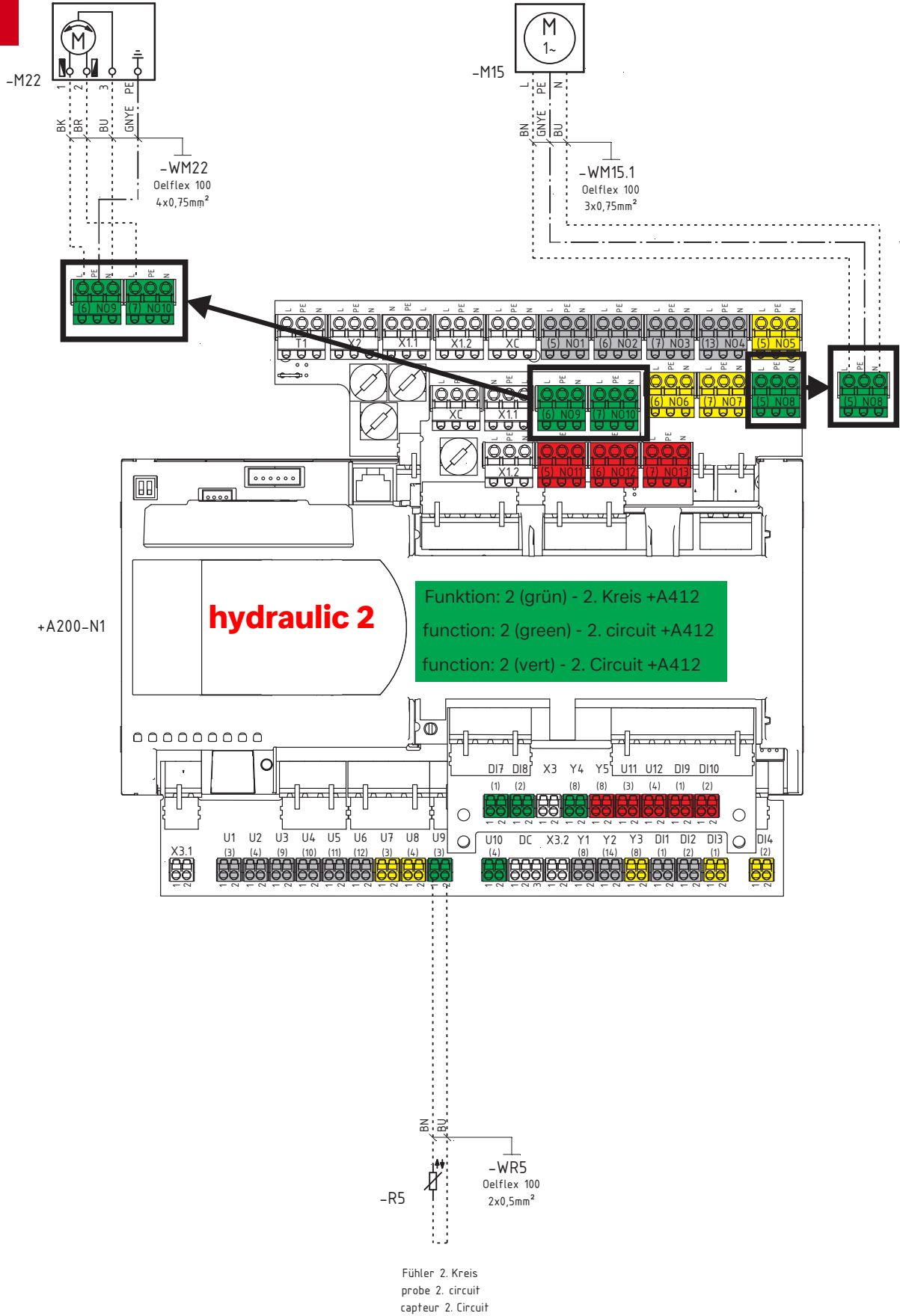

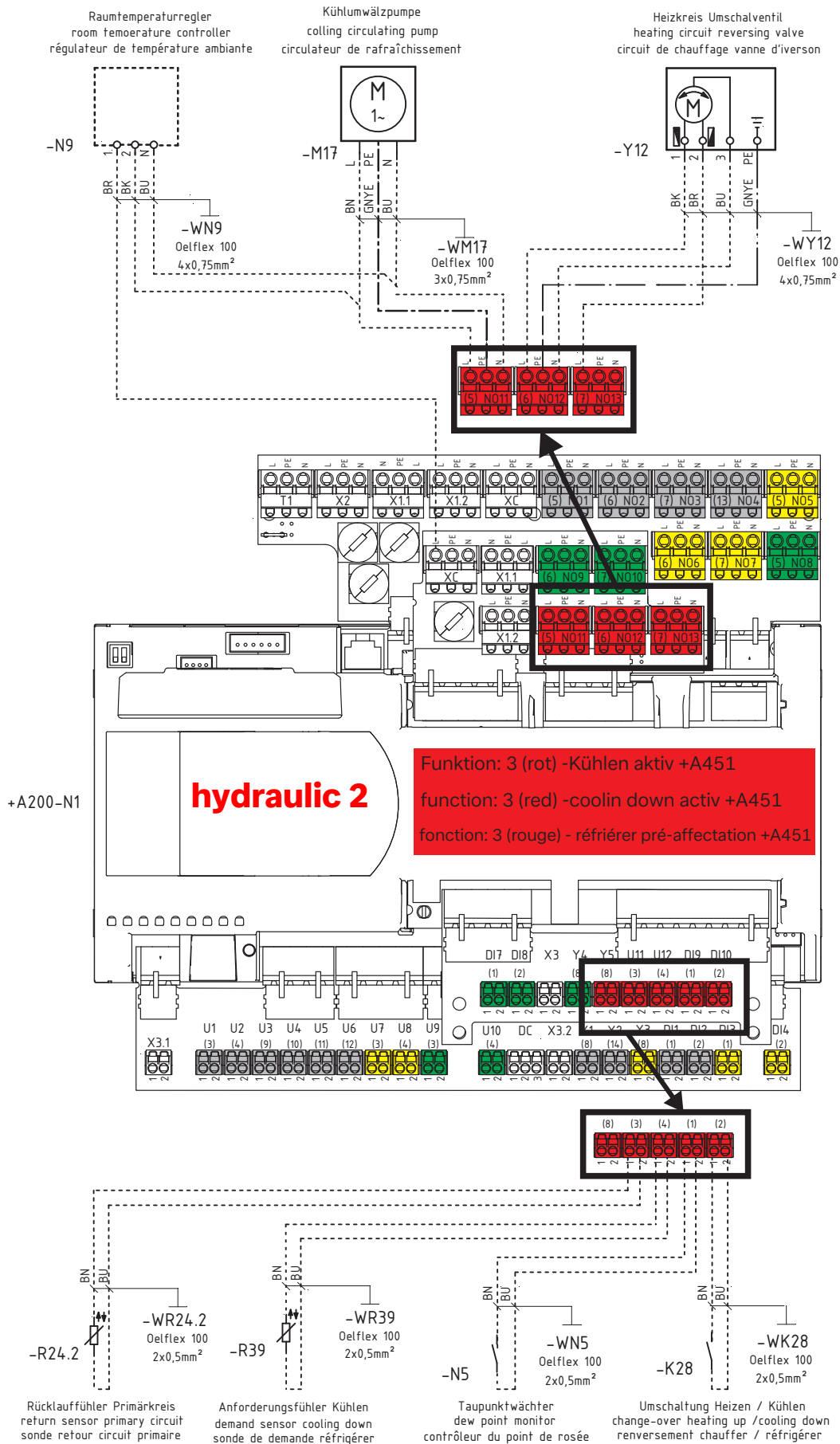



**Glen
Dimplex**
Deutschland

Dimplex