



APPLICATION

Roof fans, exhaust are designed for ventilation systems of buildings with low levels of air pollution.

They are used in:

- exhaust systems of residential buildings, supermarkets,
- industrial halls, workshops, warehouses, toilets,
- garages, parking lots, outhouse and others.

CONSTRUCTION

- Rotors with backward blades are made of plastic or aluminum sheet (depending on the model),
- The base are made of aluminum sheet,
- housing are made of aluminum sheet,
- canopy made of aluminum sheet,
- protective mesh made of galvanized sheet steel.
- designed for vertical work
- suitable for mounting on flat roofs,
- working temperature -40°C to 70°C depending on model.

MOTOR

- asynchronous, single phase, 230V, 50Hz induction motor with external rotor,
- asynchronous, three phase, 400V, 50Hz induction motor with external rotor,
- motors adapted for smooth speed control.

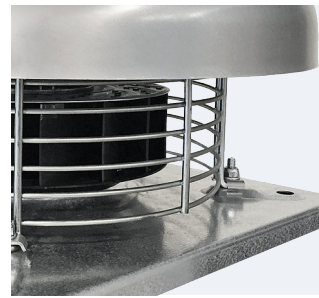

Protective mesh



Easy access to the terminal box

TECHNICAL CHARACTERISTICS

Type	maximum absorbed power	speed	voltage	maximum absorbed current	airflow at free discharge	pressure max	sound pressure level*	operating temp. max	weight	insulator class/ safety class IP	regulator	ErP	article number
	[W]	[r.p.m.]	[V]	[A]	[m³/h]	[Pa]	[dB(A)]	[°C]	[kg]				
RF/2-125S	50	2640	230	0,38	480	325	63	70	3,5	B/44	TLR 15 DS/RVS 1,5	2018	43528010
RF/4-125S	39	1430	230	0,2	260	85	46	60	3,5	B/44	TLR 15 DS/RVS 1,5	2018	43528015
RF/2-160S	101	2700	230	0,4	880	400	66	65	4	B/44	TLR 15 DS/RVS 1,5	2018	43528031
RF/2-160S/H	150	2730	230	0,7	1220	518	65	70	4	B/44	TLR 15 DS/RVS 1,5	2018	43528033
RF/4-160S	39	1425	230	0,2	604	139	65	70	4	B/44	TLR 15 DS/RVS 1,5	2018	43528036
RF/4-160S/L	34	1412	230	0,2	470	120	53	55	3,3	B/44	TLR 15 DS/RVS 1,5	2018	43528037
RF/2-200S	271	2762	230	1,2	1560	630	62	70	6,9	B/44	TLR 15 DS/RVS 1,5	2018	43528040
RF/4-200S	99	1400	230	0,4	1120	207	53	55	6,4	B/44	TLR 15 DS/RVS 1,5	2018	43528050
RF/4-250S	132	1430	230	0,69	1570	177	51	65	9	B/44	TLR 25 DS/RVS 1,5	2018	43528060
RF/4-250T	139	1400	400	0,33	1520	239	52	60	9	B/44	RMT1,5/ Inverter 0,4 kW	2018	43528080
RF/6-250S	47	960	230	0,2	895	120	42	60	9	B/44	TLR 15 DS/RVS 1,5	2018	43528100
RF/4-315S	220	1370	230	1,1	2430	219	55	60	10	B/44	TLR 15 DS/RVS 1,5	2018	43528070
RF/4-315T	330	1380	400	0,68	3300	290	58	60	11	B/44	RMT 1,5/ Inverter 0,4 kW	2018	43528090
RF/6-315S	70	950	230	0,33	1750	131	45	60	9,5	B/44	TLR 15 DS/RVS 1,5	2018	43528110

PERFORMANCE CURVES

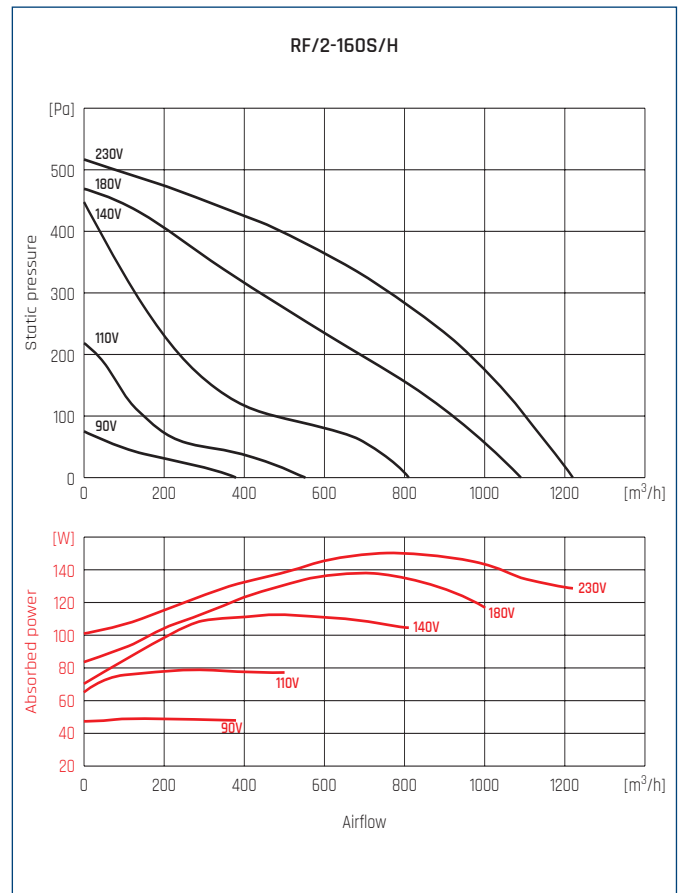
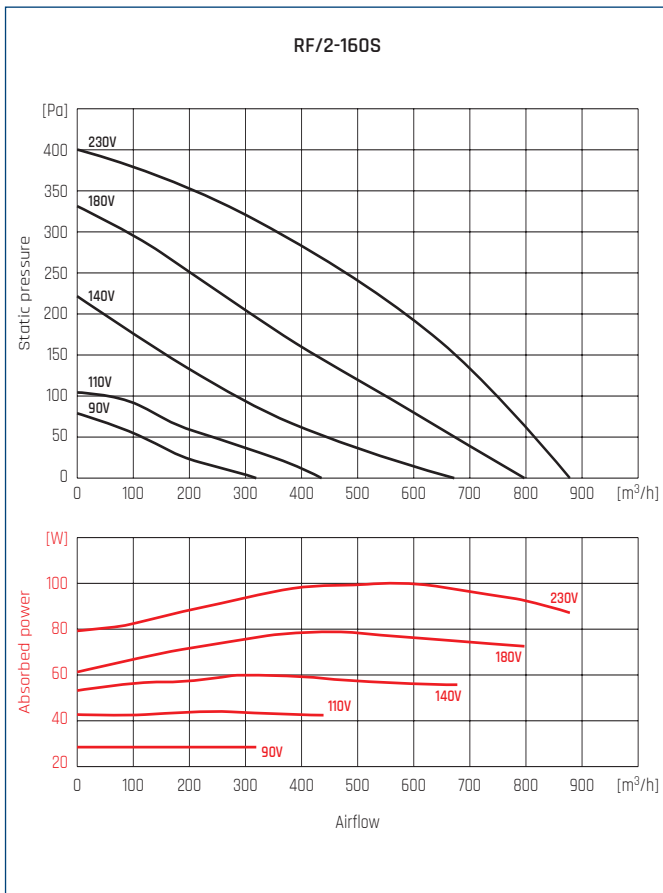
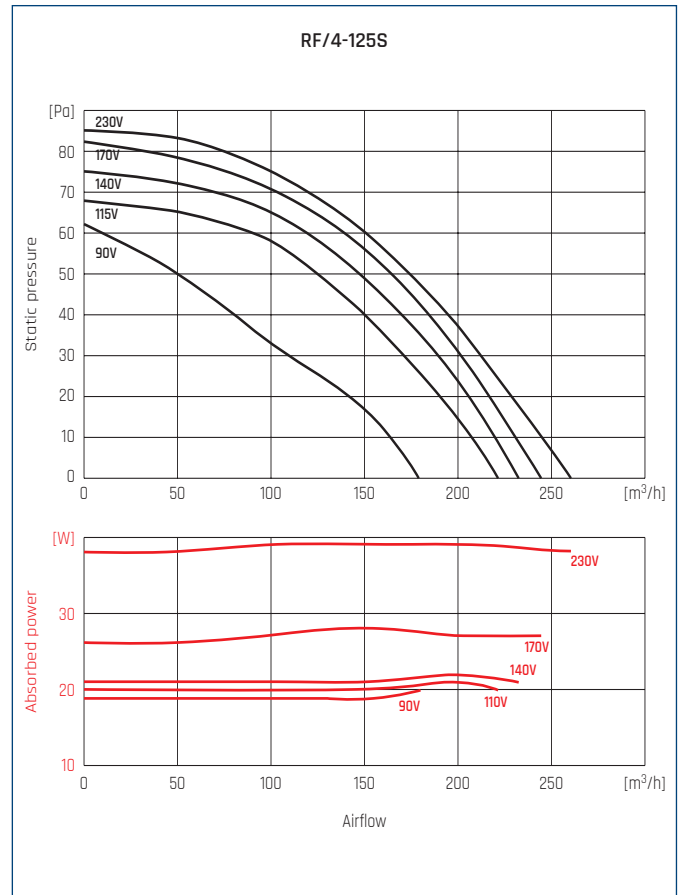
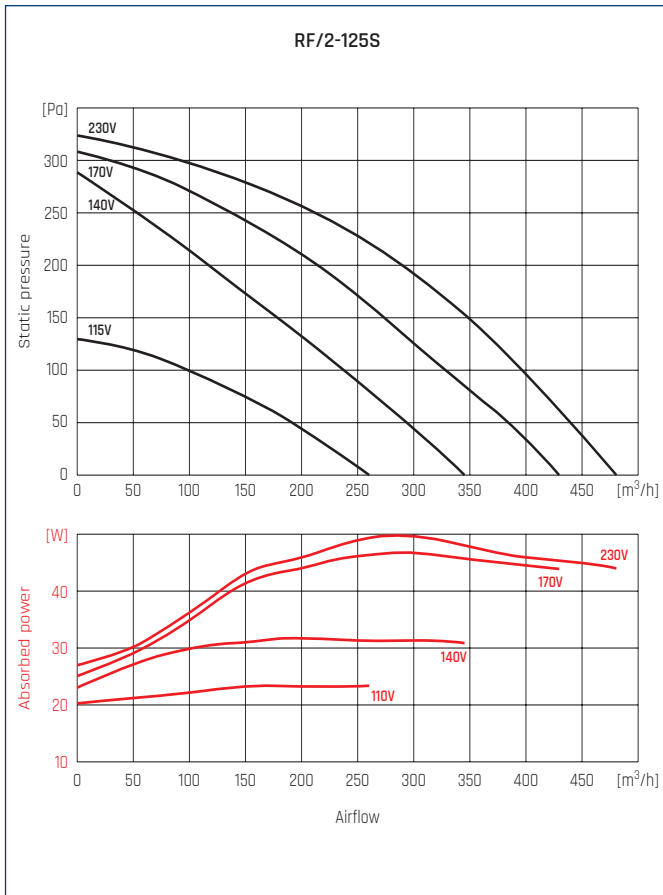

PERFORMANCE CURVES

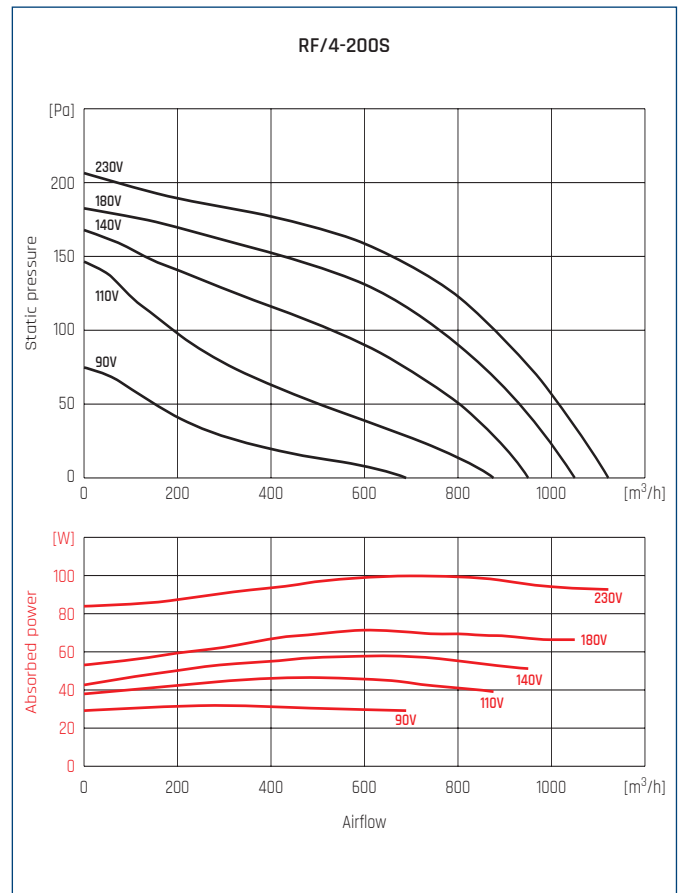
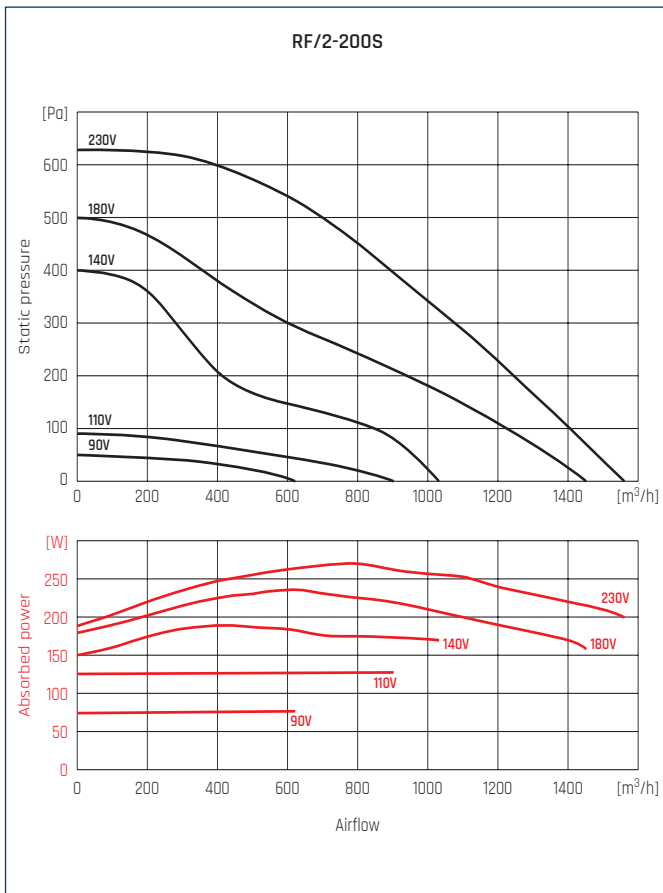
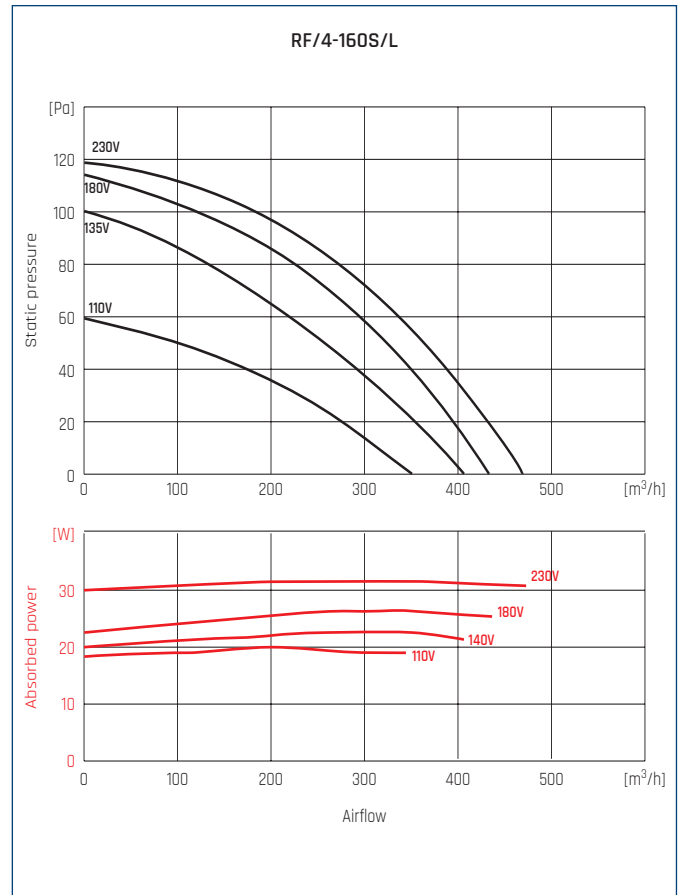
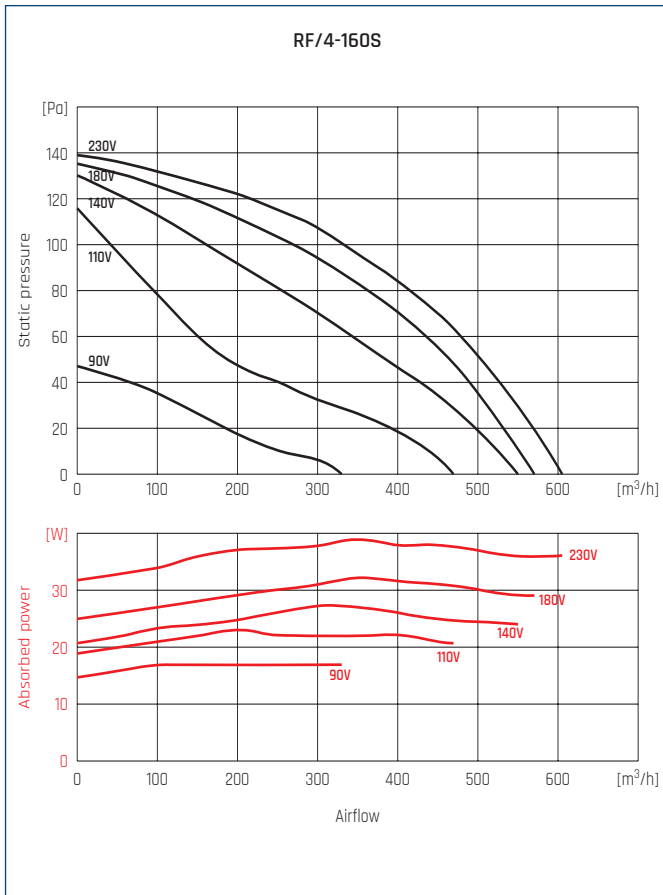

PERFORMANCE CURVES

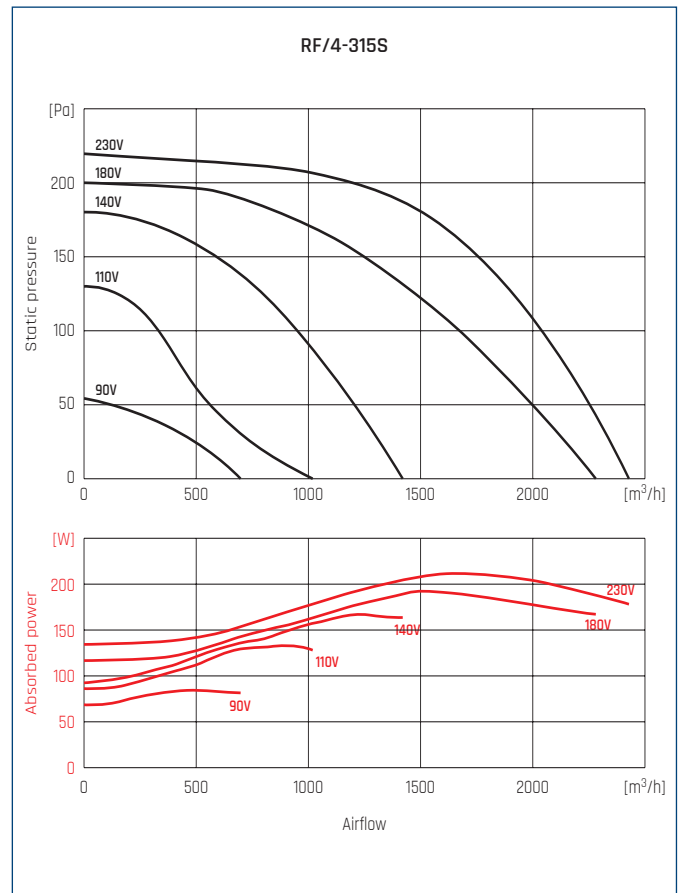
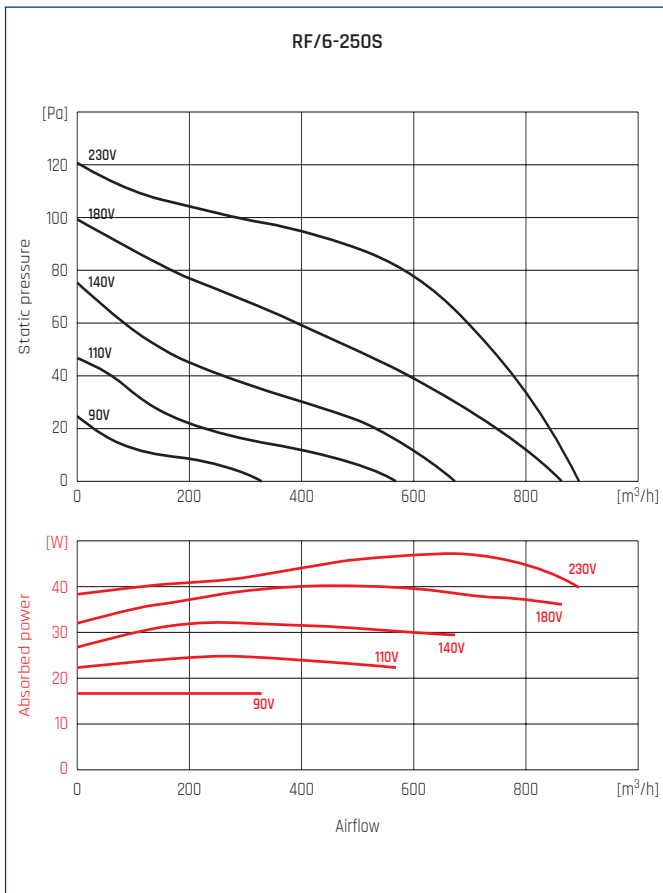
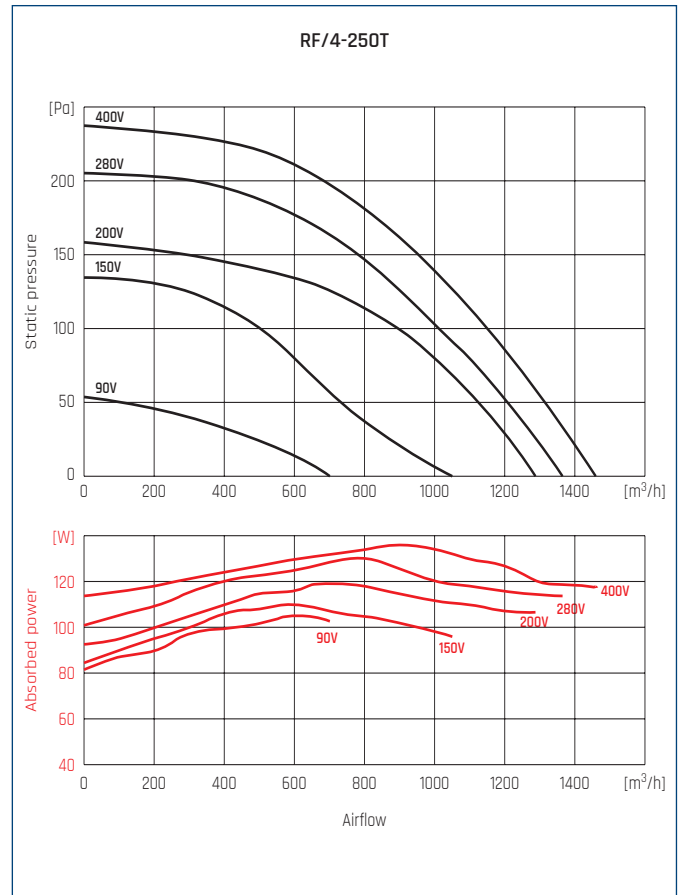
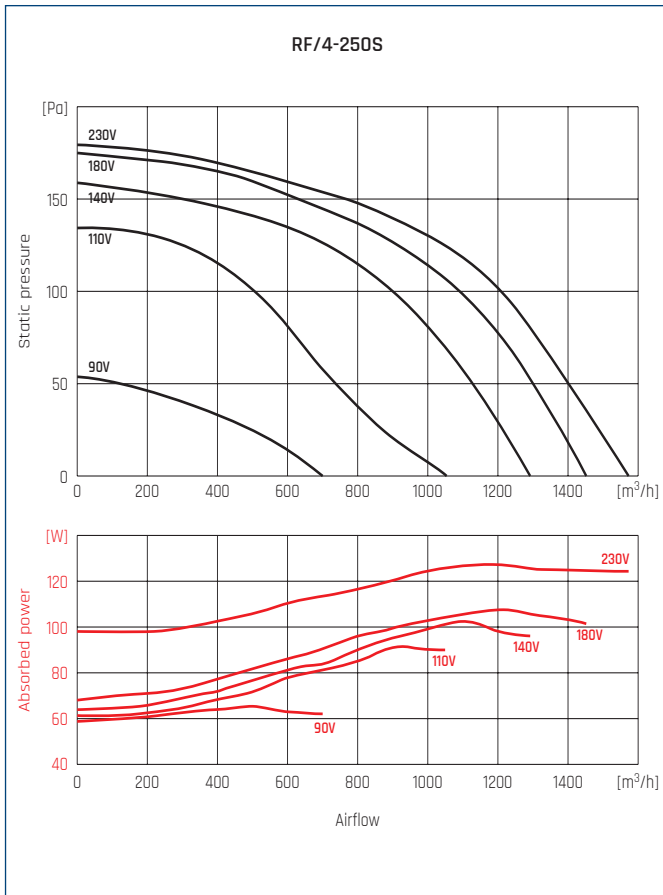

PERFORMANCE CURVES

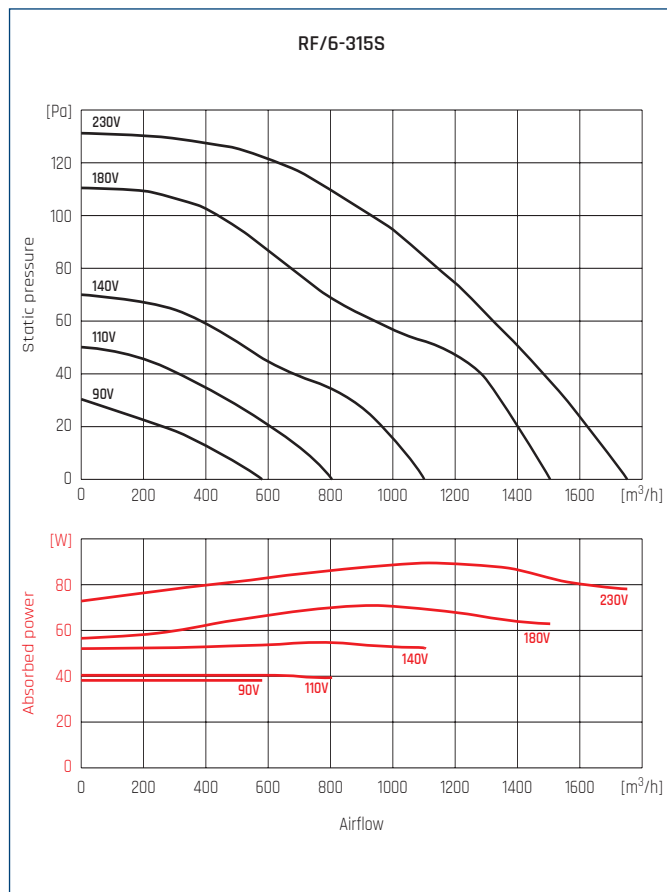
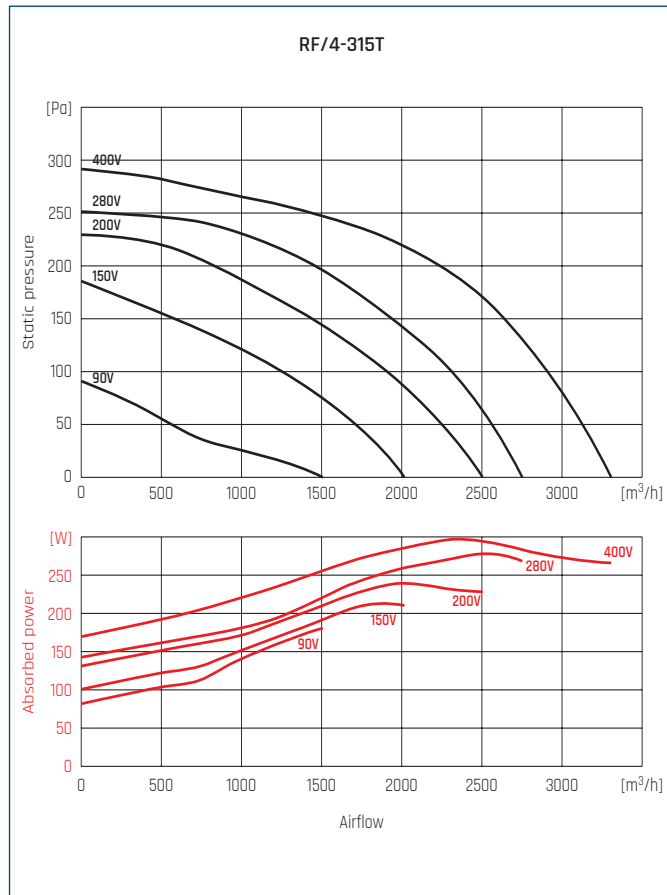

ACOUSTIC CHARACTERISTICS

Sound power level at the fan outlet in dB (A) for different frequency ranges in three points of characteristics:

Type		125	250	500	1000	2000	4000	8000	L _{WA}
RF/2-125S	Qmax	41	52	61	64	67	63	49	76
	2/3 Qmax	38	51	59	61	63	57	45	72
	1/3 Qmax	38	56	64	62	62	56	45	72
RF/4-125S	Qmax	30	39	45	47	51	37	23	59
	2/3 Qmax	29	38	43	46	43	33	19	54
	1/3 Qmax	32	42	43	46	43	33	19	54
RF/2-160S	Qmax	46	56	66	68	69	63	54	79
	2/3 Qmax	46	55	63	65	65	59	44	75
	1/3 Qmax	50	60	62	64	66	60	47	75
RF2-160S/H	Qmax	41	58	60	65	66	63	53	76
	2/3 Qmax	40	56	57	61	61	55	49	71
	1/3 Qmax	50	57	59	62	62	55	47	72
RF/4-160S	Qmax	47	55	57	59	60	56	47	65
	2/3 Qmax	47	53	55	57	57	51	44	62
	1/3 Qmax	53	55	55	56	56	49	41	61
RF/4-160S/L	Qmax	47	52	55	57	58	55	44	63
	2/3 Qmax	43	51	54	56	56	51	42	61
	1/3 Qmax	47	50	52	54	54	48	40	60
RF/2-200S	Qmax	44	70	70	72	72	66	62	78
	2/3 Qmax	50	64	68	69	67	62	55	74
	1/3 Qmax	54	68	69	71	70	63	57	76
RF/4-200S	Qmax	44	54	58	61	62	55	43	66
	2/3 Qmax	44	54	59	59	59	50	40	64
	1/3 Qmax	46	49	53	56	57	48	38	61
RF/4-250S	Qmax	49	56	61	62	60	55	44	67
	2/3 Qmax	47	53	57	57	55	47	35	62
	1/3 Qmax	45	50	55	55	52	45	33	60
RF/4-250T	Qmax	52	57	62	63	58	55	38	67
	2/3 Qmax	48	53	58	59	54	47	34	63
	1/3 Qmax	48	53	58	59	54	47	35	63
RF/6-250S	Qmax	41	47	51	51	50	35	24	56
	2/3 Qmax	37	43	49	49	44	31	20	53
	1/3 Qmax	37	43	48	49	43	31	21	53
RF/4-315S	Qmax	52	58	61	65	62	58	48	69
	2/3 Qmax	50	56	59	63	60	54	44	67
	1/3 Qmax	48	54	58	61	58	51	42	65
RF/4-315T	Qmax	54	60	64	67	63	57	47	71
	2/3 Qmax	52	58	63	66	62	55	45	69
	1/3 Qmax	50	56	61	64	60	52	42	67
RF/6-315S	Qmax	44	48	53	53	50	41	25	58
	2/3 Qmax	40	46	52	52	49	42	26	56
	1/3 Qmax	41	46	51	53	48	39	25	57

DIMENSIONS [mm]

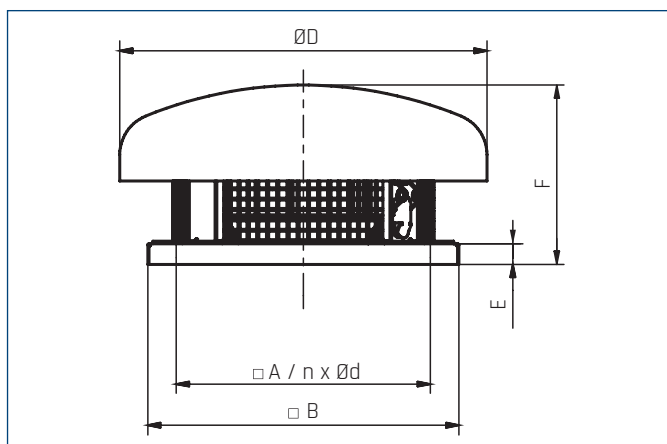

Typ	□A	□B	ØD	E	F	Ød	n
RF/2-125	245	300	355	15	191	10	4
RF/4-125	245	300	355	15	191	10	4
RF/2-160	245	300	355	15	191	10	4
RF/2-160/H	245	300	355	15	191	10	4
RF/4-160	245	300	355	15	191	10	4
RF/2-200	330	435	457	15	246	12	4
RF/4-200	330	435	457	15	259	12	4
RF/4-250	330	435	552	15	327	12	4
RF/4-250T	330	435	552	15	327	12	4
RF/6-250	330	435	552	15	327	12	4
RF/4-315	330	435	552	15	327	12	4
RF/4-315T	330	435	552	15	327	12	4
RF/6-315	330	435	552	15	327	12	4

ACCESSORY ASSEMBLY

NOTE! DESIGN CHANGES

The connector PZK is available as a separate accessory [PZK 125, PZK 160, PZK 200, PZK 250, PZK 315]. See assembly "type A" when using a PZK connector. Otherwise, see assembly "type B" for proper installation.

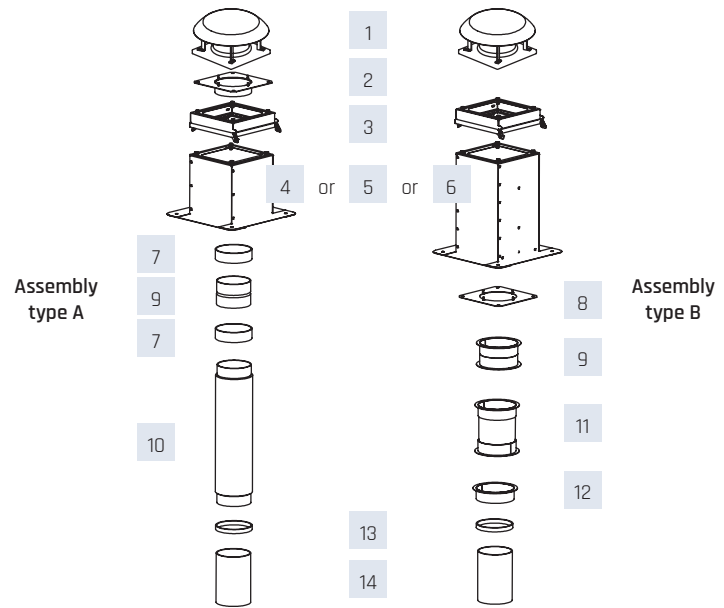

Type of assembly	Type	plate with stub	Swing module	flat roof up stand RSS	flat roof up RS	flat roof up RSA	anti-vibration bandage
	1	2	3	4	5	6	7
A	RF/x-125	PZK 100 / PZK 125	U 300	RSS 300	RS 300	-	ACOP PL 125
B						RSA 300	-
A	RF/x-160	PZK 160	U 300	RSS 300	RS 300	-	ACOP PL 160
B		-				RSA 300	-
A	RF/x-200	PZK 200	U 435	RSS 435	RS 435	-	ACOP PL 200
B		-				RSA 435	-
A	RF/x-250	PZK 250	U 435	RSS 435	RS 435	-	ACOP PL 250
B		-				RSA 435	-
A	RF/x-315	PZK 315	U 435	RSS 435	RS 435	-	ACOP PL 315
B		-				RSA 435	-

Type of assembly	Type	Mounting plate	backflow preventer	duct silencer	connector anti-vibration	stub-pipe	duct clips	Vntilation duct
	1	8	9	10	11	12	13	14
A	RF/x-125	-	CAR-PL 125	AKU-COMP 125/0.6	-	-	SBF 135	VENTAL 127
B		P 300	KZD 300	-	ZPD 300	K 300	SBF 215	VENTAL 185
A	RF/x-160	-	CAR-PL 160	AKU-COMP 160/0.6	-	-	SBF 165	VENTAL 165
B		P 300	KZD 300	-	ZPD 300	K 300	SBF 215	VENTAL 185
A	RF/x-200	-	CAR-PL 200	AKU-COMP 200/0.6	-	-	SBF 215	VENTAL 203
B		P 435	KZD 435	-	ZPD 435	K 435	SBF 325	VENTAL 254
A	RF/x-250	-	CAR-PL 250	AKU-COMP 250/0.6	-	-	SBF 325	VENTAL 254
B		P 435	KZD 435	-	ZPD 435	K 435	SBF 325	VENTAL 254
A	RF/x-315	-	CAR-PL 315	AKU-COMP 315/0.6	-	-	SBF 325	VENTAL 315
B		P 435	KZD 435	-	ZPD 435	K 435	SBF 325	VENTAL 254

Article numbers

ACOP PL 125	40521815	CAR-PL 125	40521020-01	P 300	43526300	RSA 300	43526110	U 435	43527210
ACOP PL 160	40521820	CAR-PL 160	40521030-01	P 435	43526310	RSA 435	43526120	VENTAL 127	11027127
ACOP PL 200	40521825	CAR-PL 200	40521040-01	PZK 100	43528600	RSS 300	43526510	VENTAL 165	11027165
ACOP PL 250	40521830	CAR-PL 250	40521050-01	PZK 125	43528610	RSS 435	43526520	VENTAL 185	11027185
ACOP PL 315	40521835	CAR-PL 315	40521060-01	PZK 160	43528620	SBF 135	18520135	VENTAL 203	11027203
AKU-COMP 125/0.6	40521520	K 300	43526400	PZK 200	43528630	SBF 165	18520165	VENTAL 254	11027254
AKU-COMP 160/0.6	40521530	K 435	43526410	PZK 250	43528640	SBF 215	18520215	VENTAL 315	11027315
AKU-COMP 200/0.6	40521540	KZD 300	43527300	PZK 315	43528650	SBF 325	18520325	ZPD 300	43527400
AKU-COMP 250/0.6	40521550	KZD 435	43527310	RS 300	43526010	U 300	43527200	ZPD 435	43527410
AKU-COMP 315/0.6	40521560			RS 435	43526020				

ELECTRICAL ACCESSORIES

Type	wall thermostat	duct thermostat	air quality sensor	humidistat	thyristor controller		
	TS	TK-1	SQA	HIG-2	REB N	REB NE	TLR
RF/2-125S	TS	TK-1	SQA	HIG-2	REB-1N	REB-1NE	TLR 15 DS
RF/4-125S	TS	TK-1	SQA	HIG-2	REB-1N	REB-1NE	TLR 15 DS
RF/2-160S	TS	TK-1	SQA	HIG-2	REB-1N	REB-1NE	TLR 15 DS
RF/2-160S/H	TS	TK-1	SQA	HIG-2	REB-1N	REB-1NE	TLR 15 DS
RF/4-160S	TS	TK-1	SQA	HIG-2	REB-1N	REB-1NE	TLR 15 DS
RF/4-160S/L	TS	TK-1	SQA	HIG-2	REB-1N	REB-1NE	TLR 15 DS
RF/2-200S	TS	TK-1	SQA	HIG-2	REB-2,5N	REB-2,5NE	TLR 25 DS
RF/4-200S	TS	TK-1	SQA	HIG-2	REB-1N	REB-1NE	TLR 15 DS
RF/4-250S	TS	TK-1	SQA	HIG-2	REB-2,5N	REB-2,5NE	TLR 25 DS
RF/4-250T	TS + DILM7	TK-1 + DILM7-10	SQA + DILM7-10	HIG-2 + DILM7-10	-	-	-
RF/6-250S	TS	TK-1	SQA	HIG-2	REB-1N	REB-1NE	TLR 15 DS
RF/4-315S	TS	TK-1	SQA	HIG-2	REB-2,5N	REB-2,5NE	TLR 25 DS
RF/4-315T	TS + DILM7	TK-1 + DILM7-10	SQA + DILM7-10	HIG-2 + DILM7-10	-	-	-
RF/6-315S	TS	TK-1	SQA	HIG-2	REB-1N	REB-1NE	TLR 15 DS

Type	11-speed thyristor controller	2-adjustable 6-speed thyristor controller	ERV	transformer regulator			transformer regulator 2-adjustable		inverter	service switch
	IRF	RND-1		RMB	RVS	RMT	SC2	SC2A		
RF/2-125S	IRF-900	RND-1	ERV-3	RMB-1.5	RVS-1.5	-	SC2-1-15L25	SC2A1-15L25	-	R-S 1-F + SP, 10A
RF/4-125S	IRF-900	RND-1	ERV-3	RMB-1.5	RVS-1.5	-	SC2-1-15L25	SC2A1-15L25	-	R-S 1-F + SP, 10A
RF/2-160S	IRF-900	RND-1	ERV-3	RMB-1.5	RVS-1.5	-	SC2-1-15L25	SC2A1-15L25	-	R-S 1-F + SP, 10A
RF/2-160S/H	IRF-900	RND-1	ERV-3	RMB-1.5	RVS-1.5	-	SC2-1-15L25	SC2A1-15L25	-	R-S 1-F + SP, 10A
RF/4-160S	IRF-900	RND-1	ERV-3	RMB-1.5	RVS-1.5	-	SC2-1-15L25	SC2A1-15L25	-	R-S 1-F + SP, 10A
RF/4-160S/L	IRF-900	RND-1	ERV-3	RMB-1.5	RVS-1.5	-	SC2-1-15L25	SC2A1-15L25	-	R-S 1-F + SP, 10A
RF/2-200S	IRF-900	RND-1	ERV-3	RMB-1.5	RVS-1.5	-	SC2-1-15L25	SC2A1-15L25	-	R-S 1-F + SP, 10A
RF/4-200S	IRF-900	RND-1	ERV-3	RMB-1.5	RVS-1.5	-	SC2-1-15L25	SC2A1-15L25	-	R-S 1-F + SP, 10A
RF/4-250S	IRF-900	RND-1	ERV-3	RMB-1.5	RVS-1.5	-	SC2-1-15L25	SC2A1-15L25	-	R-S 1-F + SP, 10A
RF/4-250T	-	-	-	-	-	RMT-1.5	-	SC2A4-15L55	L 0.4kW	R-S 3-F + SP, 10A
RF/6-250S	IRF-900	RND-1	ERV-3	RMB-1.5	RVS-1.5	-	SC2-1-15L25	SC2A1-15L25	-	R-S 1-F + SP, 10A
RF/4-315S	IRF-900	RND-1	ERV-3	RMB-1.5	RVS-1.5	-	SC2-1-15L25	SC2A1-15L25	-	R-S 1-F + SP, 10A
RF/4-315T	-	-	-	-	-	RMT-1.5	-	SC2A4-15L55	L 0.4kW	R-S 3-F + SP, 10A
RF/6-315S	IRF-900	RND-1	ERV-3	RMB-1.5	RVS-1.5	-	SC2-1-15L25	SC2A1-15L25	-	R-S 1-F + SP, 10A

Article numbers

TS	40025345	REB-1NE	40025020	IRF-900	40015154	RMT 1,5	40025100	R-S 1-F + SP, 10A	91040907-01
TK-1	40025330	REB-2,5N	40025030	RND-1	40025630	SC2-1-15L25	40025250	R-S 3-F + SP, 10A	91040908-01
SQA	40025140	REB-2,5NE	40025040	ERV-3	40025046	SC2A1-15L25	40025251	DILM7-10	91040997
HIG-2	40025150	TLR 15 DS	40025025	RMB 1,5	40025060	SC2A4-15L55	40025270		
REB-1N	40025010	TLR 25 DS	40025045	RVS 1,5	40025232	L 0.4kW	40016302		

flat roof up stand RS	flat roof up stand RSA	flat roof up stand RSS	backflow preventer KZD	backflow preventer CAR-PL	duct silencer AKU-COMP	duct clips SBF	line VENTAL	connector P	stub-pipe K
connector anti-vibra.ZPD	anti-vibra. bandage ACOP PL	plate with stub PZK	swing module U	thermostat TS	thermostat TK-1	sensor SQA	humidistat HIG-2	regulator REB	regulator TLR
regulator IRF	regulator RND-1	regulator ERV	regulator RMB	regulator RVS	transformer regulator 2-adj.	inverter	service switch	connector DILM	

ERP CHARACTERISTICS

SWM*			
	Nazwa produktu	RF/4-125S	RF/4-125S**
a	supplier name	VENTURE INDUSTRIES	VENTURE INDUSTRIES
b	article number	43528015	43528015
c	SEC average [kWh/m ² .a]	-17,14	-28,30
c	SEC cold	-33,55	-55,36
c	SEC warm	-7,75	-12,79
c	SEC class	E	B
d	device category	RVU	RVU
d	device type	UVU or one-way	UVU or one-way
e	type of drive	stepless control fan of speed rotation system	stepless control fan of speed rotation system
f	type of heat recovery system	not applicable	not applicable
g	thermal efficiency of heat recovery [%]	not applicable	not applicable
h	maximum flow rate [m ³ /h]	169	169
i	electric power input [W]	39	39
	sound power level [dB(A)]	54	54
k	reference flow rate [m ³ /s]	0,03	0,03
l	reference pressure difference [Pa]	50	50
m	SPI [W/m ³ /h]	0,000230769	0,000230769
n	CRS/CTRL	1	1
o	maximum external leakage rate [%]	0	0
p	mixing rate	not applicable	not applicable
q	position of visual filter warning	not applicable	not applicable
r	instructions to install supply grilles	not applicable	not applicable
s	internet address	www.ventur.eu	www.ventur.eu
t	airflow sensitivity to pressure variation	not applicable	not applicable
u	indoor/outdoor air tightness [m ³ /h]	not applicable	not applicable
v	annual electricity consumption - average climate [kWh/a]	289	122
v	annual electricity consumption - cold climate [kWh/a]	289	122
v	annual electricity consumption - warm climate [kWh/a]	289	122
w	annual heating saved - cold climate [kWh/a]	3355	5536
w	annual heating saved - average climate [kWh/a]	1715	2830
w	annual heating saved - warm climate [kWh/a]	776	1280
	MISC	1,1	1,1
	CRS	1	0,65
	x-value	1	2

* RVU - "residential ventilation unit" - according to COMMISSION REGULATION (EU) No 1253/2014

** Device using control as required

ERP CHARACTERISTICS

SWNM*								
	Nazwa produktu	RF/2-125S	RF/2-160S	RF/2-160S/H	RF/4-160S	RF/4-160S/L	RF/2-200S	RF/4-200S
a	supplier name	VENTURE INDUSTRIES	VENTURE INDUSTRIES	VENTURE INDUSTRIES	VENTURE INDUSTRIES	VENTURE INDUSTRIES	VENTURE INDUSTRIES	VENTURE INDUSTRIES
b	article number	43528010	43528031	43528033	43528036	43528036	43528040	43528050
c	device category	NRVU	NRVU	NRVU	NRVU	NRVU	NRVU	NRVU
c	device type	UVU one-way	UVU one-way	UVU one-way	UVU one-way	UVU one-way	UVU one-way	UVU one-way
d	type of drive	stepless control fan of speed rotation system	stepless control fan of speed rotation system	stepless control fan of speed rotation system	stepless control fan of speed rotation system	stepless control fan of speed rotation system	stepless control fan of speed rotation system	stepless control fan of speed rotation system
e	type of heat recovery system	not applicable	not applicable	not applicable	not applicable	not applicable	not applicable	not applicable
f	thermal efficiency of heat recovery [%]	not applicable	not applicable	not applicable	not applicable	not applicable	not applicable	not applicable
g	reference flow rate in NRVU [m ³ /s]	0,07	0,14	0,22	0,11	0,07	0,26	0,20
h	electric power input [kW]	0,049	0,101	0,153	0,038	0,032	0,26	0,099
i	SFPint [W/(m ³ /s)]	705,60	737,53	711,63	348,98	315,6	987,34	504,82
j	face velocity [m/s]	0,47	0,77	1,22	0,62	0,59	1,20	0,89
k	$\Delta p_{s, ext}$ [Pa]	225	243	300	87	92	359	147
l	$\Delta p_{s, int}$ [Pa]	not applicable	not applicable	not applicable	not applicable	not applicable	not applicable	not applicable
m	$\Delta p_{s, add}$ [Pa]	not applicable	not applicable	not applicable	not applicable	not applicable	not applicable	not applicable
n	static efficiency of fans [%]	32,03%	32,80%	42,20%	24,80%	20,60%	36,29%	29,20%
o	maximum external leakage rate [%]	0	0	0	0	0	0	0
p	energy performance	not applicable	not applicable	not applicable	not applicable	not applicable	not applicable	not applicable
q	visual filter warning	not applicable	not applicable	not applicable	not applicable	not applicable	not applicable	not applicable
r	L_{wa} [dB(A)]	72	75	76	61	62	75	64
s	internet address	www.ventur.eu	www.ventur.eu	www.ventur.eu	www.ventur.eu	www.ventur.eu	www.ventur.eu	www.ventur.eu

SWNM*							
	Nazwa produktu	RF/4-250S	RF/4-250T	RF/6-250S	RF/4-315S	RF/4-315T	RF/6-315S
a	supplier name	VENTURE INDUSTRIES	VENTURE INDUSTRIES	VENTURE INDUSTRIES	VENTURE INDUSTRIES	VENTURE INDUSTRIES	VENTURE INDUSTRIES
b	article number	43528060	43522080	43528100	43528070	43528090	43528110
c	device category	NRVU	NRVU	NRVU	NRVU	NRVU	NRVU
c	device type	UVU one-way	UVU one-way	UVU one-way	UVU one-way	UVU one-way	UVU one-way
d	type of drive	stepless control fan of speed rotation system	stepless control fan of speed rotation system	stepless control fan of speed rotation system	stepless control fan of speed rotation system	stepless control fan of speed rotation system	stepless control fan of speed rotation system
e	type of heat recovery system	not applicable	not applicable	not applicable	not applicable	not applicable	not applicable
f	thermal efficiency of heat recovery [%]	not applicable	not applicable	not applicable	not applicable	not applicable	not applicable
g	reference flow rate in NRVU [m ³ /s]	0,26	0,25	0,17	0,42	0,61	0,28
h	electric power input [kW]	0,115	0,136	0,047	0,208	0,29	0,09
i	SFPint [W/(m ³ /s)]	440,89	554,47	276,47	492,31	475,41	325,30
j	face velocity [m/s]	1,14	1,07	0,74	1,65	2,38	1,08
k	$\Delta p_{s, ext}$ [Pa]	134	176	75	183	201	98
l	$\Delta p_{s, int}$ [Pa]	not applicable	not applicable	not applicable	not applicable	not applicable	not applicable
m	$\Delta p_{s, add}$ [Pa]	not applicable	not applicable	not applicable	not applicable	not applicable	not applicable
n	static efficiency of fans [%]	30,22%	31,64%	27,00%	37,06%	42,40%	29,10%
o	maximum external leakage rate [%]	0	0	0	0	0	0
p	energy performance	not applicable	not applicable	not applicable	not applicable	not applicable	not applicable
q	visual filter warning	not applicable	not applicable	not applicable	not applicable	not applicable	not applicable
r	L_{wa} [dB(A)]	62	63	53	67	69	56
s	internet address	www.ventur.eu	www.ventur.eu	www.ventur.eu	www.ventur.eu	www.ventur.eu	www.ventur.eu

* NRVU - "non-residential ventilation unit" - according to COMMISSION REGULATION (EU) No 1254/2014.