

Series HKV PnG and HKV-R PnG

Heating manifold with quick connection Push'n'Go

Technical Datasheet

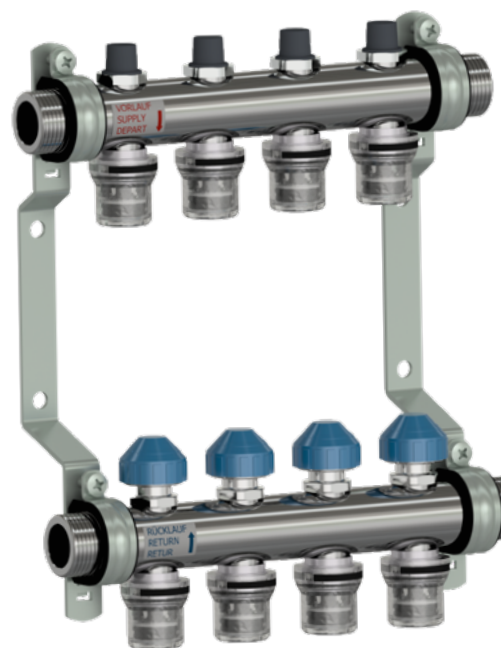
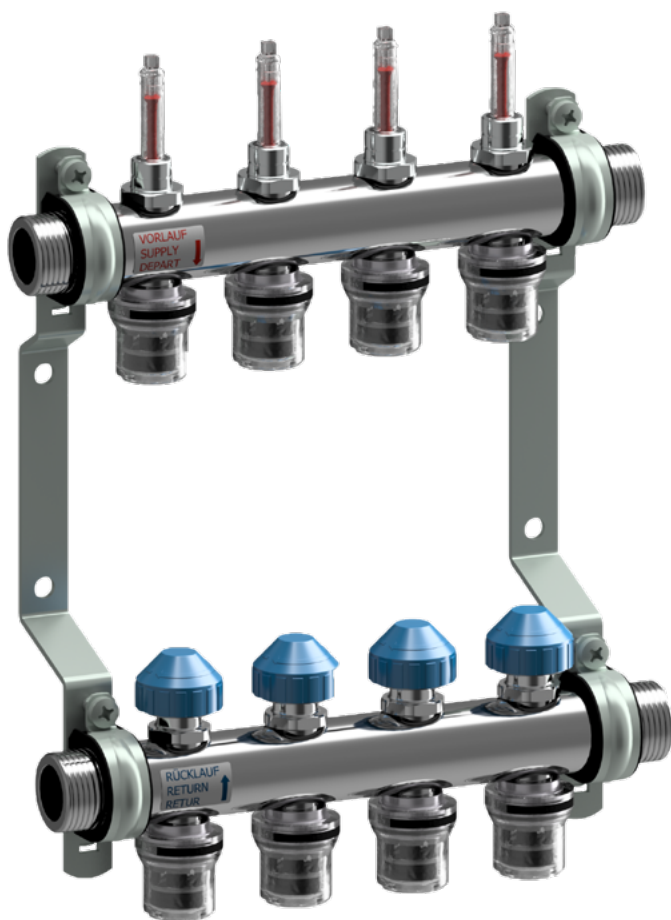

Description

Stainless steel heating circuit manifolds series HKV **Push'n'Go** and HKV-R **Push'n'Go** are used for radiant panel heating or cooling systems. The **Push'n'Go** push-fit connector enables quick connection of pipework to the heating circuit manifold.

HKV PnG

Stainless steel round pipe manifold according to **DIN EN 1264-4**. Flat-sealing 1" male connection on both sides for manifold accessories and manifold control station. Pre-assembled **Push'n'Go** connectors on outlets for connection of Ø 16 mm PEX pipe according to **DIN EN ISO 15875-2** or PERT pipe. Centre distance of the outlets 50 mm. Ready-mounted on wall bracket, pipe clamps sound-insulated according to DIN 4109.

Supply (top): Shut-off flow meter with very low pressure loss. Flow rate display 0-4 l/min.

Return (bottom): regulating and shut-off valves with adaptation M30x1.5. Closing dimension 11.8 mm.

- Type HKV 0-4 1" VA PnG **Pur**: Manifold only.
- Type HKV 0-4 1" VA PnG **Med**: Manifold complete with end pieces ES-SET Quattro 1" (see description on page 7).
- Type HKV 0-4 1" VA PnG **Pro**: Manifold complete with ball valves KH-SET WMZ and end pieces ES-SET Quattro 1" (see description on page 7).

Typ	Part no.		Weight
HKV 0-4 1" VA PnG Pur 02	10084923	for 2 heating circuits	1.51 kg
HKV 0-4 1" VA PnG Pur 03	10084924	for 3 heating circuits	1.83 kg
HKV 0-4 1" VA PnG Pur 04	10084925	for 4 heating circuits	2.26 kg
HKV 0-4 1" VA PnG Pur 05	10084926	for 5 heating circuits	2.58 kg
HKV 0-4 1" VA PnG Pur 06	10084927	for 6 heating circuits	3.02 kg
HKV 0-4 1" VA PnG Pur 07	10084928	for 7 heating circuits	3.49 kg
HKV 0-4 1" VA PnG Pur 08	10084929	for 8 heating circuits	3.81 kg
HKV 0-4 1" VA PnG Pur 09	10084930	for 9 heating circuits	4.10 kg
HKV 0-4 1" VA PnG Pur 10	10084931	for 10 heating circuits	4.52 kg
HKV 0-4 1" VA PnG Pur 11	10084932	for 11 heating circuits	4.89 kg
HKV 0-4 1" VA PnG Pur 12	10084933	for 12 heating circuits	5.33 kg
HKV 0-4 1" VA PnG Med 02	10084905	for 2 heating circuits	1.93 kg
HKV 0-4 1" VA PnG Med 03	10084906	for 3 heating circuits	2.25 kg
HKV 0-4 1" VA PnG Med 04	10084907	for 4 heating circuits	2.68 kg
HKV 0-4 1" VA PnG Med 05	10084908	for 5 heating circuits	3.00 kg
HKV 0-4 1" VA PnG Med 06	10084909	for 6 heating circuits	3.44 kg
HKV 0-4 1" VA PnG Med 07	10084910	for 7 heating circuits	3.91 kg
HKV 0-4 1" VA PnG Med 08	10084911	for 8 heating circuits	4.23 kg
HKV 0-4 1" VA PnG Med 09	10084912	for 9 heating circuits	4.51 kg
HKV 0-4 1" VA PnG Med 10	10084913	for 10 heating circuits	4.94 kg
HKV 0-4 1" VA PnG Med 11	10084914	for 11 heating circuits	5.31 kg
HKV 0-4 1" VA PnG Med 12	10084915	for 12 heating circuits	5.74 kg
HKV 0-4 1" VA PnG Pro 02	10084890	for 2 heating circuits	2.71 kg
HKV 0-4 1" VA PnG Pro 03	10084891	for 3 heating circuits	3.03 kg
HKV 0-4 1" VA PnG Pro 04	10084892	for 4 heating circuits	3.46 kg
HKV 0-4 1" VA PnG Pro 05	10084893	for 5 heating circuits	3.78 kg
HKV 0-4 1" VA PnG Pro 06	10084894	for 6 heating circuits	4.22 kg
HKV 0-4 1" VA PnG Pro 07	10084895	for 7 heating circuits	4.69 kg
HKV 0-4 1" VA PnG Pro 08	10084896	for 8 heating circuits	5.01 kg
HKV 0-4 1" VA PnG Pro 09	10084897	for 9 heating circuits	5.30 kg
HKV 0-4 1" VA PnG Pro 10	10084898	for 10 heating circuits	5.72 kg
HKV 0-4 1" VA PnG Pro 11	10084899	for 11 heating circuits	6.09 kg
HKV 0-4 1" VA PnG Pro 12	10084900	for 12 heating circuits	6.53 kg

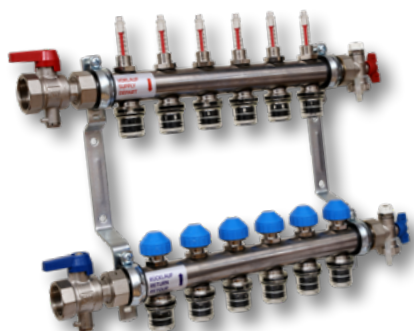
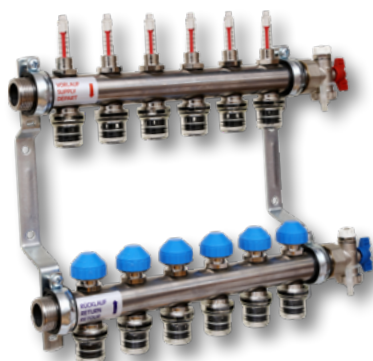
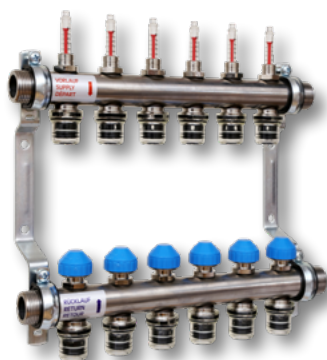

HKV-R PnG

Stainless steel round pipe manifold according to **DIN EN 1264-4**. Flat-sealing 1" male connection on both sides for manifold accessories and manifold control station. Pre-assembled **Push'n'Go** connectors on outlets for connection of Ø 16 mm PEX pipe according to **DIN EN ISO 15875-2** or PERT pipe. Centre distance of the outlets 50 mm. Ready-mounted on wall bracket, pipe clamps sound-insulated according to DIN 4109.

Supply (top): Fine-control and shut-off valve.

Return (bottom): regulating and shut-off valves with adaptation M30 x 1.5. Closing dimension 11.8 mm.

Manifold complete with end pieces ES-SET Quattro 1" (see description on page 7).

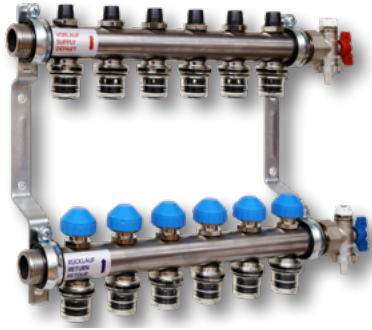

Typ	Part no.	Weight
HKV-R 1" VA PnG Med 02	10084934 for 2 heating circuits	2.27 kg
HKV-R 1" VA PnG Med 03	10084935 for 3 heating circuits	2.47 kg
HKV-R 1" VA PnG Med 04	10084936 for 4 heating circuits	2.85 kg
HKV-R 1" VA PnG Med 05	10084937 for 5 heating circuits	3.42 kg
HKV-R 1" VA PnG Med 06	10084938 for 6 heating circuits	3.71 kg
HKV-R 1" VA PnG Med 07	10084939 for 7 heating circuits	4.08 kg
HKV-R 1" VA PnG Med 08	10084940 for 8 heating circuits	4.66 kg
HKV-R 1" VA PnG Med 09	10084941 for 9 heating circuits	4.94 kg
HKV-R 1" VA PnG Med 10	10084942 for 10 heating circuits	5.36 kg
HKV-R 1" VA PnG Med 11	10084943 for 11 heating circuits	6.48 kg
HKV-R 1" VA PnG Med 12	10084944 for 12 heating circuits	6.85 kg

Technical Data HKV PnG and HKV-R PnG

Hydraulic data	
Max. operating pressure	6 bar
Medium temperature	5 to 55° C
Media	Water or water with glycol as per VDI 2035
Connections	
Primary circuit and end set	G 1" male thread
Tightening torque	1" screw fittings: 55 Nm
Heating circuit	Ø 16 PE-X pipe in accordance with DIN EN ISO 15875-2 or PER-T pipe Important: not suitable for connecting to aluminium composite pipes
Connection for actuator	M30 x 1.5 / closing point 11.8 mm / stroke 2.5 mm
Materials	
Manifold	Stainless steel 1.4301
Flow meter	CW 617 N, PPS
O-rings	EPDM
Flat seals	AFM/2
Push'n'Go plug-in connection	PA, EPDM, AISI, POM, Grivory, CW 617 N
End set (optional)	CW 617 N

Pressure loss curves

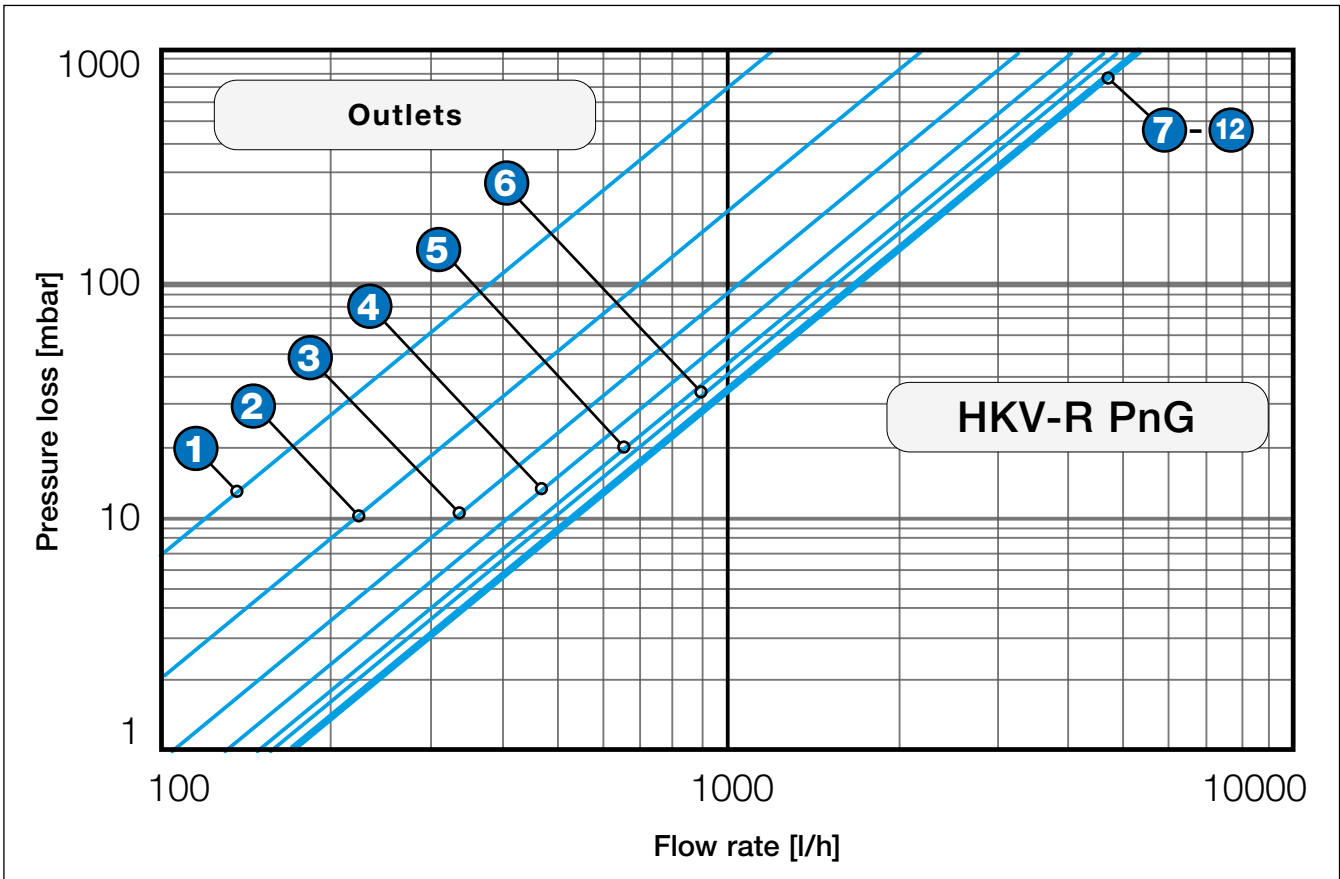
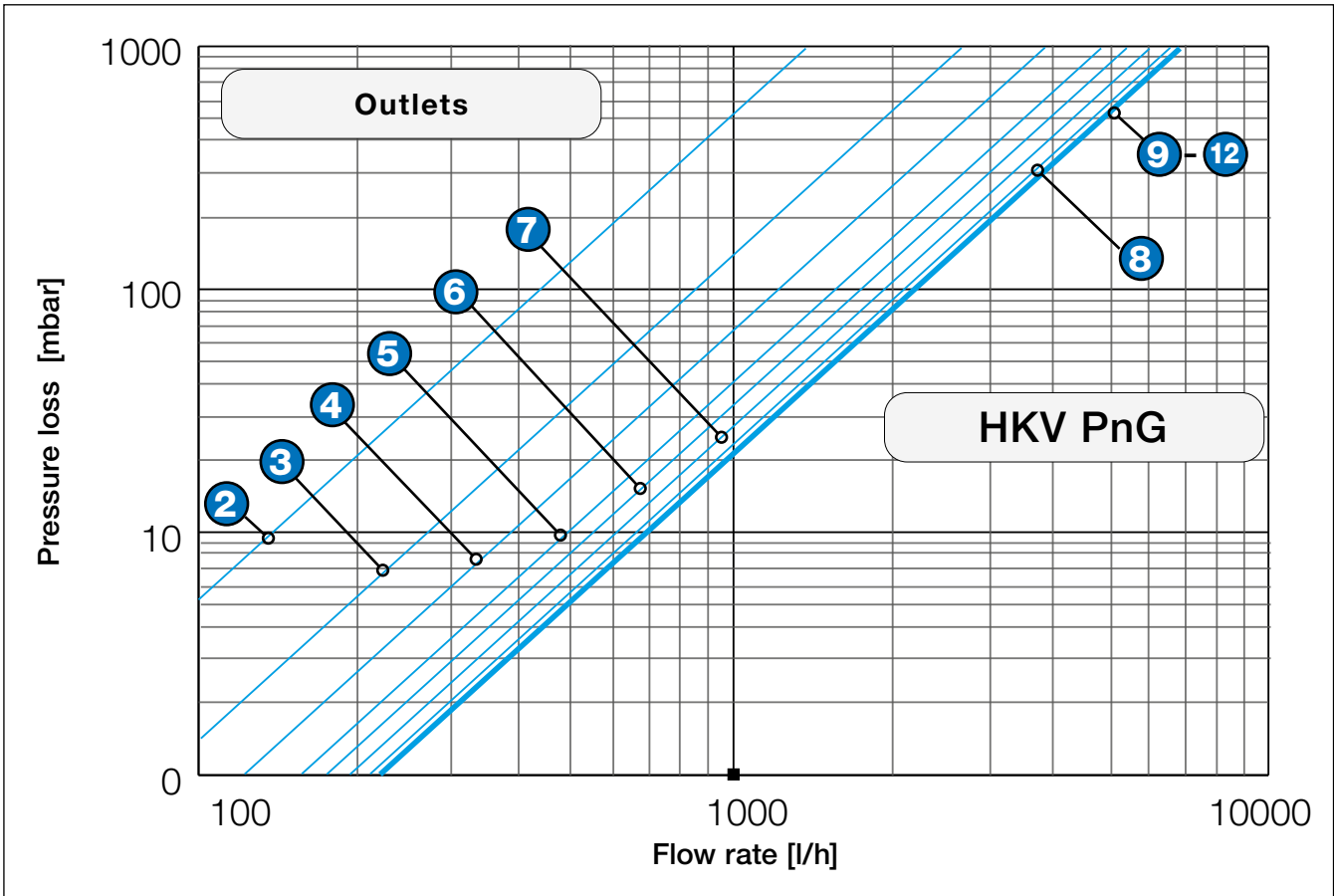

Application

The Watts stainless steel heating circuit manifolds series HKV **Push'n'Go** and HKV-R **Push'n'Go** are used to distribute, shut off and regulate the heating/cooling water flow of surface heating/cooling systems in accordance with DIN EN 1264-4. The **Push'n'Go** connector enables quick and easy connection of the heating circuit manifold to heating and cooling circuits. In addition, with these manifolds the required hydraulic balancing can be carried out very easily via the regulating valves and, with the HKV **Push'n'Go** series, can be checked and read via the flow meters.

Quick pipe installation with Push n Go connector

The **Push'n'Go** connectors are factory-mounted on the manifold outlets, allowing quick and easy pipe installation without special tools in just 3 steps:

1. Push the PE-X pipe into the **Push'n'Go** connector until it meets the stop.
2. Pull the pipe back out so that it hooks in and is fixed in place.
3. Check the correct position of the pipe using the sight glass.

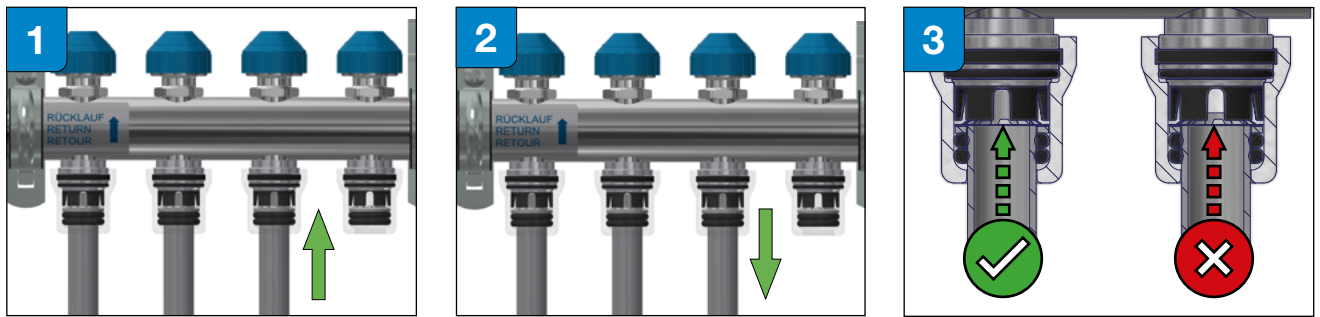

Flow adjustment

Series HKV PnG: The flow rate for each heating circuit is set on the return control valve and visually checked on the corresponding flow meter.

Series HKV-R PnG: The flow rate for each heating circuit is set on the flow regulating valve using the setting diagram.

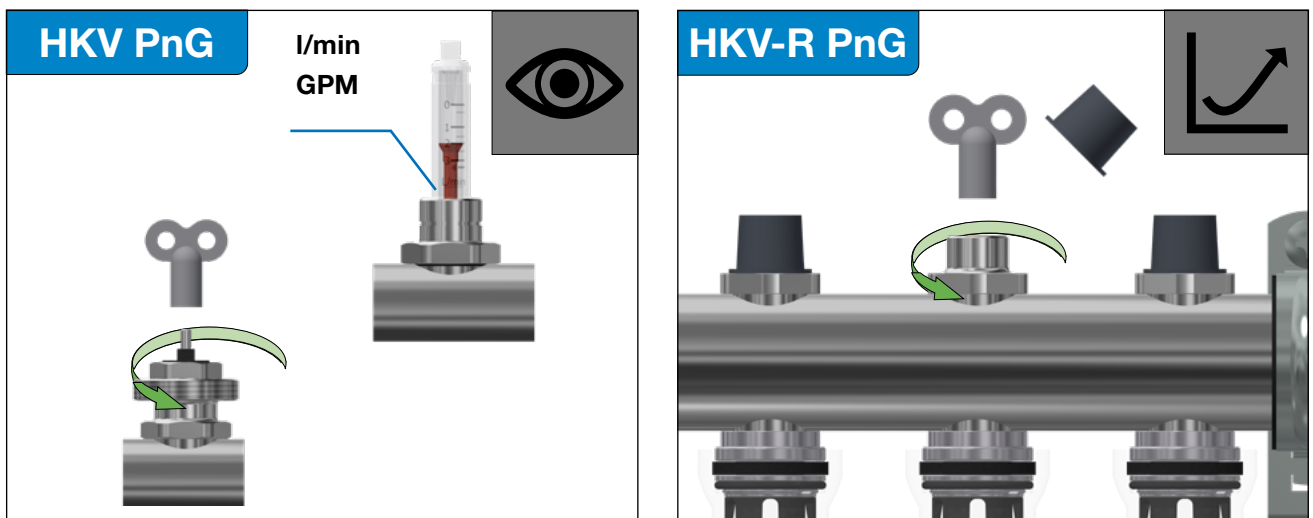

Dimensions HKV PnG and HKV-R PnG [mm]

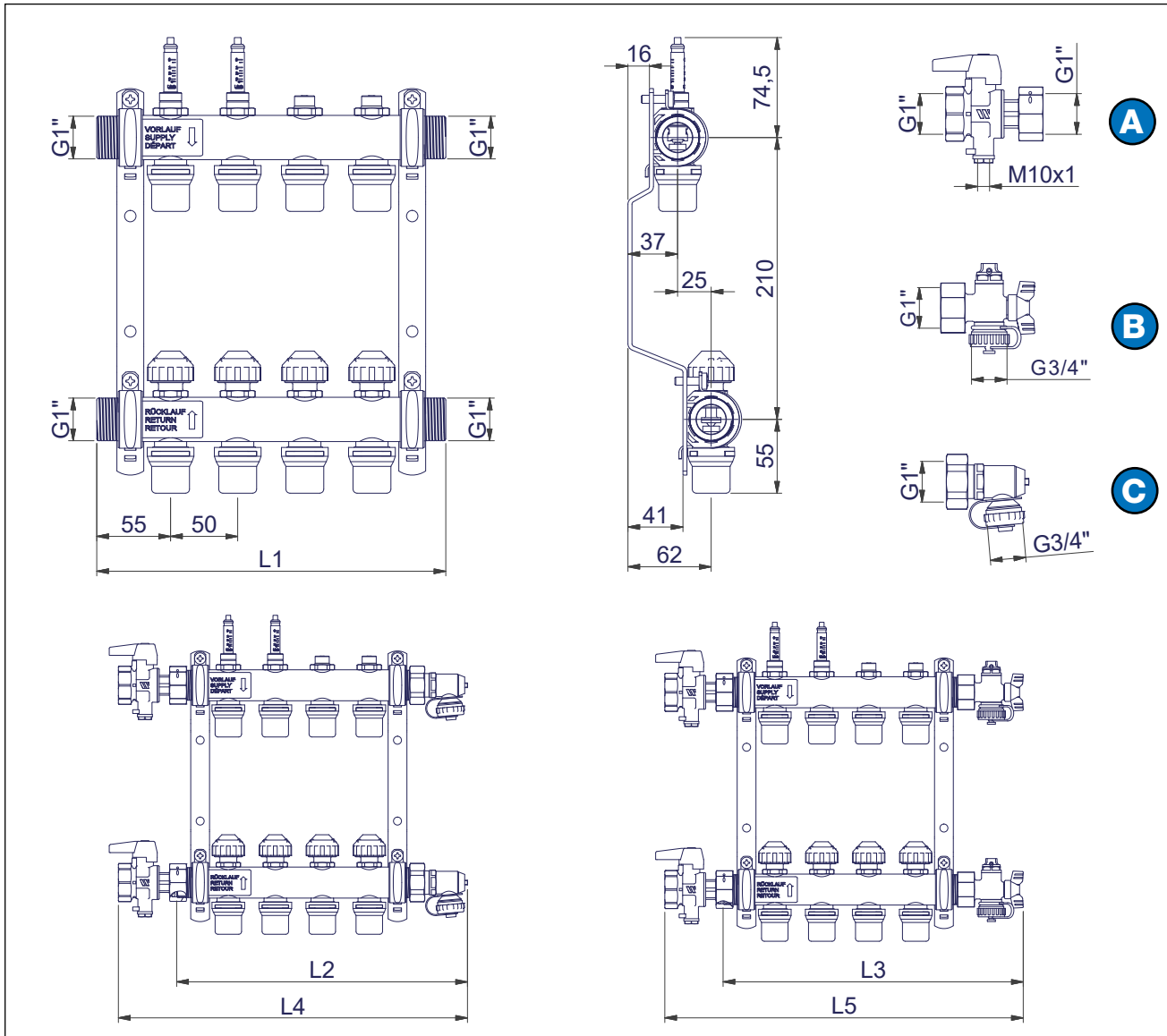

Combination	Outlets											
Heating manifold + accessories	2	3	4	5	6	7	8	9	10	11	12	
L1 = HKV / HKV-R	160.0	210.0	260.0	310.0	360.0	410.0	460.0	510.0	560.0	610.0	660.0	
L2 = HKV / HKV-R + ES-SET KFE90 (C)	209.5	259.5	309.5	359.5	409.5	459.5	509.5	559.5	609.5	659.5	709.5	
L3 = HKV / HKV-R + ES-SET Quattro 1" (B)	219.4	269.4	319.4	369.4	419.4	469.4	519.4	569.4	619.4	669.4	719.4	
L4 = KH-SET WMZ (A) + HKV / HKV-R + ES-SET KFE90 (C)	271.5	321.5	371.5	421.5	471.5	521.5	571.5	621.5	671.5	721.5	771.5	
L5 = KH-SET WMZ (A) + HKV / HKV-R + ES-SET Quattro 1" (B)	281.4	331.4	381.4	431.4	481.4	531.4	581.4	631.4	681.4	731.4	781.4	

Accessories

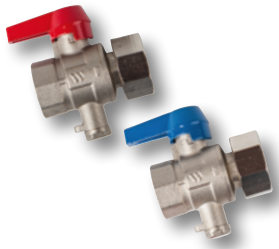

Ball valve set KH-SET WMZ

Ball valve set G 1" with connection M10 x 1 for short direct sensors for heat meters according to EN 1434. Brass body, with union nut and gasket. Nickel plated. Included in the scope of delivery of the heating circuit manifold type **Pro**.

Typ	Part no.		Weight
KH-SET WMZ	10028597	1" UN x 1" F	0.78 kg

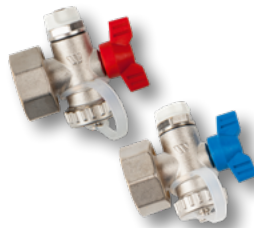

End set ES-SET Quattro 1"

Ball valve with handle for easy filling, rinsing and draining. Brass body, with union and gaskets. Nickel plated. Included in the scope of delivery of the heating circuit manifolds type **Med** and **Pro**.

Typ	Part no.		Weight
ES-SET Q 1" Ni	10022835	1" UN	0.42 kg

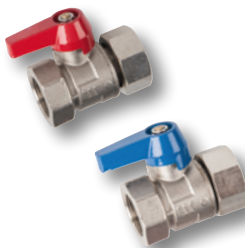

Ball valve set KH-SET HKV

Brass body, with union nut and gasket. Nickel plated. Optionally available.

Typ	Part no.		Weight
KH-SET HKV	10022871	1" UN x 1" F	0.66 kg



End set KFE90 1"

Ball valve for filling, rinsing and draining. Brass body, with union and gaskets. Nickel plated. Optionally available.

Typ	Part no.		Weight
ES-SET KFE90 1"Ni	10028149	1" UN	0.38 kg



Manifold insulation

Snap-fit EPP heat insulation for manifolds with 1" male thread and 50 mm distance of connection nipples, suitable for manifolds for 6 heating circuits. Excess modules can be cut off when used for smaller manifolds. Use 2 insulations for larger manifolds. Delivery includes one insulation each for supply and return pipe as well as a knife to adapt the insulation to different manifold sizes.

Typ	Part no.		Weight
HKV-ISO	10023474	HKV 1", 50 mm	0.35 kg



Actuator 22CX

Electrothermic ON/OFF actuator with position indicator. For control and shut-off valves with connection M30 x 1.5. Compatible with heating circuit manifolds HKV PnG and HKV-R PnG. Max. Stroke 3.5 mm / working stroke 2.5 mm. Power consumption 1.8 W. Cable length approx. 1 m. Protection class IP54. NA: normally open; NC: normally closed.

Typ	Part no.		Weight
22CX24VNA2	10029672	24V, NA	0.17 kg
22CX24VNC2	10029673	24V, NC	0.17 kg
22CX230NA2	10029674	230V, NA	0.17 kg
22CX230NC2	10029671	230V, NC	0.17 kg



Control unit Isomix-F

Ready-to-mount, compact control unit to control supply temperature in radiant panel heating systems up to 14 kW heat demand.

Supply temperature setting range: 20–70 °C, temperature limiting and locking facility on thermostatic head. Pre-wired pump and temperature limiter. Can be mounted on the right or left side of the manifold. Suitable for all Watts 1" M heating circuit manifolds. Nickel plated.

Typ	Part no.		Weight
Isomix-F	10084161	Wilo PARA SCU/6	3,83 kg
Isomix-F	10084635	Grundfos UPM3A/7	3,88 kg

Specification texts

Watts Heating circuits manifolds Series HKV PnG with plug connector for 2 - 12 heating circuits

Stainless steel round pipe manifold for 2 to 12 heating circuits in accordance with DIN EN 1264-4. 1" M connection on both sides for manifold accessories and control unit. Shut-off flow meter with very low pressure loss on the supply. Flow rate display 0-4 l/min. Regulating and shut-off valves with adaptation M30x1.5 on the return. Closing dimension 11.8 mm. Pre-assembled Push n Go connectors on the outlets for connection of Ø 16 mm PEX pipe according to **DIN EN ISO 15875-2**. Centre distance of the outlets 50 mm. Max. operating pressure 6 bar. Flow at the top, ready-mounted on wall bracket, pipe clamps sound-insulated according to DIN 4109.

Watts Heating circuits manifolds Series HKV-R PnG with plug connector for 2 - 12 heating circuits

Stainless steel round pipe manifold for 2 to 12 heating circuits in accordance with DIN EN 1264-4. 1" M connection on both sides for manifold accessories and control unit. Fine adjustment and shut-off valves on the supply and shut-off valves with adaptation M30x1.5 on the return. Closing dimension 11.8 mm. Pre-assembled Push n Go connectors at the outlets for connection of Ø 16 mm PEX pipe according to **DIN EN ISO 15875-2**. Centre distance of the outlets 50 mm. Max. operating pressure 6 bar. Flow at the top, ready-mounted on wall bracket, pipe clamps sound-insulated according to DIN 4109.

WATTS Ball Valve Set Type KH-SET WMZ G 1" 1" F with sensor connection M10x1

Ball valve set G 1" with connection M10 x 1 for short direct sensors for heat meters according to EN 1434. Brass body, 1" with union nut and gasket. Internal thread 1".

WATTS End Set Quattro 1" Type ES-SET Q 1" Ni

Ball valve with handle for easy filling, rinsing and draining. Brass body, with union and flat gaskets. Nickel plated. Union nut 1".

WATTS Kugelhahnset Type KH-SET HKV 1" UNx1" F, Ni

Brass body, with union nut and flat gaskets. Nickel plated. Union nut 1", internal thread 1".

WATTS End Set Type ES-SET KFE90 1" F N

Ball valve for filling, rinsing and draining. Brass body, with union and gaskets. Nickel plated.

WATTS Verteiler Isolierung Type: HKV-ISO, 1", 50 mm

Snap-fit EPP heat insulation for manifolds HKV2013A, HKV PnG and HKV-R PnG with 1" male thread and 50 mm distance of connection nipples, suitable for manifolds with 6 zones. Excess modules can be cut off when used for smaller manifolds. Use 2 insulations for larger manifolds. Delivery includes one insulation each for supply and return pipe as well as a knife to adapt the insulation to different manifold sizes.

Actuators Series 22CX

Electrothermal actuator 22CX Series WATTS brand ON/OFF action, compatible with radiator valves, fan coil valves and manifolds. Hood in self-extinguishing polymeric material. Nickel-plated brass nut M30x1.5. Version NC or NO. Version with 230VAC or 24VAC/DC with 2 or 4 wires with auxiliary micro-switch. Stroke: 3.5 mm. Power consumption: 1.6W / 1.8 W. Cable length approx. 1 m. Degree of protection IP54. Compliant with LVD 2014/35/UE, EMC 2014/30/UE. Approved TÜV.

Ready-to-mount, compact control unit Type ISOMIX-F

Ready-to-mount, compact control unit to control supply temperature in radiant panel heating systems up to 14 kW heat demand. Supply temperature setting range: 20–70 °C, temperature limiting and locking facility on thermostatic head. Pre-wired pump and temperature limiter. Can be mounted on the right or left side of the manifold. Suitable for all Watts 1" M heating circuit manifolds. Nickel plated.

The descriptions and photographs contained in this product specification sheet are supplied by way of information only and are not binding. Watts Industries reserves the right to carry out any technical and design improvements to its products without prior notice. Warranty: All sales and contracts for sale are expressly conditioned on the buyer's assent to Watts terms and conditions found on its website at www.wattsindustries.com. Watts hereby objects to any term, different from or additional to Watts terms, contained in any buyer communication in any form, unless agreed to in a writing signed by an officer of Watts.

WATTS®

Watts Industries Deutschland GmbH

Godramsteiner Hauptstr. 167 • 76829 Landau • Deutschland

Tel. +49 6341 96 560 • Fax +49 6341 9656 560

WIDE@wattswater.com • www.wattswater.de